



THERMAL PRINTER

Operator ' s Manual

Rev.C

• SW (400dpi)

[ 220-240V AC ]

**NITTO DENKO**

# Important Safeguard

## Important Safety Instructions

### Symbols

Various symbols are used in manuals (including this manual) and on the printer body to help you use this product properly and to prevent harm to you and other people and the damages to the property. The symbols and their meanings are shown below.



Warning • • • This mark indicates that a death or a serious injury may occur if you handle this printer improperly ignoring the warning.





Caution • • • This mark indicates that a slight injury or damage to property may occur if you handle this printer improperly, ignoring the caution.

### Examples



shows that you must pay enough attention to something.  
Sometimes this mark indicates a hazard or a warning.



The mark  shows that something is prohibited.  
In , what is prohibited is shown specifically.  
For example, the mark at the left shows that disassembly is prohibited.



- Shows that you are required to do something.
- In the required act is shown specifically. For example, the mark at the left shows that connection to a ground is required.

For the safe use of this printer, the following safety precautions should always be followed.

## Warnings



- Be sure to connect the ground. A leakage of current without the grounding may cause an electric shock or a fire. If there is no grounding terminal, ask an electrician to set up one. Do not use this printer without grounding.



- Be sure to use this printer at the rated power supply voltage. Do not use a multi-outlet adapter to avoid an electric shock and a fire.
- Do not use an extension cord.
- Do not break damage or adapt the power cord. It is also prohibited to put heavy materials on the cord and to yank or bend the cord excessively. A damaged power cord may cause an electric shock or a fire.



- Set up the printer as close as possible to the receptacle so that you can easily unplug the power cord under abnormal conditions.



- Do not disassemble or adapt the printer to avoid an electric shock or a fire.
- Follow the instructions on the manuals in maintenance and inspection. Improper handling may cause an electric shock or a fire.



- When abnormal conditions such as smoke or abnormal odors coming from the machine are encountered, turn the power off at once, unplug the power cord and then make contact with your service representative. It may cause a fire or an electric shock to keep using the printer under abnormal conditions.
- When some foreign material such as a piece of metal, water and other liquid goes into the printer, turn the power off at once, unplug the power cord and then make contact with your service representative. It may cause an electric shock or a fire to keep using the printer under abnormal conditions.



- Do not put a vase, a flower pot, a cup, or a case containing liquid on the printer. The spilt water may cause an electric shock or a fire.



- Do not plug or unplug the power cord with moistened hands to avoid an electric shock.

For the safe use of this printer, the following safety precautions should always be followed.

## Cautions



- Do not place the printer where it will be exposed to dust, dirt and dampness to avoid a fire or an electric shock.
- Avoid putting the printer on an unstable place such as an unsteady or an inclined rack and so on. The printer may fall down or drop down on someone and may cause an injury.



- Unplug the power cord before you move the printer. A damaged power cord may cause a fire or an electric shock.
- If you do not use the printer for a long time, remove the line cord plug from the receptacle for the safety reason.



- Whenever plugging or unplugging the power cord, always grasp the plug, not the cord to avoid any damage to the cord.  
A damaged power cord may cause a fire or an electric shock



- Take care not to burn your hands by touching the hot part inside the printer in clearing a paper jam, replacing the paper, or cleaning.

## DURAPRINER SW

### PREFACE

Thank you very much for your utilizing DURA PRINTER SW by NITTO DENKO.

DURA PRINTER SW is a thermal transfer label printer used with the specific labels/tags and ribbons.

This manual explains how to operate and control the DURA PRINTER SW so that you can use and maintain the printer in an optimal fashion. Before attempting to use the printer, be sure to read this manual all of the way through.

Keep this manual and the Unpacking Instructions that are packaged with the printer in a safe place for future reference.

In order to use this printer with a personal computer, the printer must be connected to the personal computer via a SCSI interface.

The requirements for using a SCSI interface are as follows:

- You must use an Adaptec SCSI host adapter (as of February, 2002)

Models : AVA-2915LP or AHA-2910C

For information on how to install the printer driver and on how to use the printer driver to set functions, refer to the Setup Guide that is packed with the printer.

Note that due to our continuing efforts to improve and refine our products, the descriptions and illustrations provided in this manual may differ slightly from your printer.

#### **A Note on EU Electromagnetic Wave Regulations**

**Use only the SCSI interface cable provided. Using any other interface cable may cause electromagnetic interference. If this happens, the user may be requested to take appropriate measures to eliminate the interference.**

- “Windows” is a registered trademark of Microsoft Corporation of the U.S.
- “Adaptec” is a registered trademark of Adaptec, Inc.
- Other product names and company names that appear in this manual are trademarks or registered trademarks of their respective owners.

## HANDLING OF DURATAACK AND DURAINK

Thank you very much for utilizing DURA PRINTER SR by NITTO DENKO.

DURAPRINTER is the thermal transfer label printer used with specific labels/tags and ribbons.

The specific labels and ink ribbons are DURATAACK series and DURAINK series.

Use non-recommended labels or ink ribbons at your own risk.

This document explains how to handle and operate the DURATAACK and DURAINK.

Before attempting to use the labels and ink ribbons, be sure to read this manual all of the way through.

Incorrect handling or use may cause print quality degradation.

## HANDLING OF DURATAACK SERIES

### 1. Storage conditions

- (1) Store the product in a well ventilated area at room temperature where it will not be exposed to direct sunlight.
- (2) The warranty period is 6 months after delivered. After expiration of the warranty period verify the product quality before use.
- (3) Do not store in a vertical state. Store it in a horizontal state.
- (4) Store product as individually packaged from manufacturer so as to prevent contamination.
- (5) The product is wound loosely so as to prevent winding deformation. Do not rewind tightly when storing.

### 2. Handling

- (1) DURATAACK has the approved size with tolerance. It is required to adjust the deviation within tolerance range by the following method (printer or application software).
  - Longitudinal direction (label size, pitch size): Adjustment of print position (up-down)
  - Lateral direction (Label size, liner left/right space): Adjustment of print position (left-right), setting of roll holder and guide.
- (2) Install according to operation manual for the printer that you use.
  - example: Position label centered on spindle to prevent ink ribbon wrinkle.
- (3) Insure there is suitable combination of ink ribbon and label depending on size, material and print energy. Unsuitable combination may cause print failure or malfunction.
- (4) Do not touch the label surface (transfer surface) with your bare hand.
  - Oil is applied and impedes ink transfer, causing print failure.
- (5) Some label rolls may have splicing areas on the liner. If the printer stops at the splicing area, restore the normal state by using the SET TOF function (the operation differs depending on the printer).
- (6) DURATAACK series labels are not designed for printing process occurring in the following conditions: outdoors, dusty environments or solvent/chemical splash locations. Print image quality is not guaranteed. Dust causes print troubles.
- (7) In principle provide the left/right and top/bottom space (about 1 mm each) in view of treatment tolerance, label setting accuracy, printer label transfer accuracy, etc. If the format deviates outward from the label, the dirty and breakage of thermal head, reduction of consumable parts life, or damage of ink ribbon may be caused.
- (8) There is incomplete print or some labels that are impossible to print on at the end of roll owing to specific printer construction. In this case take the following measures:
  - Incomplete print: Re-print on the first label after replacement of label roll (in case of re-print mode setting).
  - Impossible to print: There are some surplus provision labels in a roll.
- (9) When any option equipment such as printer synchronizing label peeling unit (peeler), label peeling machine, auto cutter unit, etc., special treatment may be required.

## HANDLING OF DURAINK SERIES

### 1. Storage conditions

- (1) Store the product in well ventilated area at room temperature where it will not be exposed to direct sunlight.
- (2) The warranty period is 6 months after delivered.  
After expiration of the warranty period verify the product quality before use.
- (3) Store product as individually packaged from manufacturer so as to prevent contamination.

### 2. Handling

- (1) Install according to operation manual for the printer that you use.  
example: Position ribbon centered on spindle to prevent ink ribbon wrinkle.
- (2) Insure there is suitable combination of ink ribbon and label depending on size, material and print energy.  
Unsuitable combination may cause print failure or malfunction. Especially, if the size of ink ribbon is equal to or smaller than the size of label liner resulting in ink ribbon wrinkles, print failure and reduction of consumable parts life or thermal head life. Also, thermal head breakage may be caused due to dirty of thermal head.
- (3) The DURAPRINTER series is designed so that the direct thermal paper can also be used.  
Existence/nonexistence of ink ribbon is not detected  
while printing direct thermal paper, and installation of ink ribbon does not cause error condition.  
The sensor detects only the silver tape at the ink ribbon end, indicating empty error.
- (4) As to the ink ribbon winding core, use the core that comes with the printer when it is newly purchased.  
After that, use the used unwinding core as a winding core (rotation).  
Be sure to discard the rewound ink ribbon and do not wind a new ink ribbon on it.
- (5) DURAINK series ribbons are not designed for reuse. Print failure will occur.
- (6) Do not touch the ink ribbon surface (transfer surface) with bare hands.  
Oil is applied and impedes ink transfer, causing print failure.
- (7) DURAINK series ribbons are not designed for printing process occurring in the following conditions:  
outdoors, dusty environments or solvent/chemical splash locations. Print image quality is not guaranteed.  
Dust causes print troubles.

# Contents

<b>1.</b>	<b>ORGANIZATION OF THIS MANUAL</b> .....	<b>1</b>
<b>2.</b>	<b>UNPACKING</b> .....	<b>2</b>
2-1.	CHECKING THE PACKING LIST .....	2
2-2.	REMOVING THE PROTECTIVE DEVICES ON THE PRINTER .....	3
<b>3.</b>	<b>INSTALLATION ENVIRONMENT AND POWER SUPPLY CONNECTION</b> .....	<b>4</b>
3-1.	INSTALLATION ENVIRONMENT .....	4
3-2.	GROUND AND POWER SUPPLY CONNECTIONS .....	5
<b>4.</b>	<b>NOTES ON USE</b> .....	<b>6</b>
4-1.	NOTES ON HANDLING .....	6
4-2.	NOTE ON USING LABELS/TAGS .....	6
4-3.	CONSUMABLES .....	6
<b>5.</b>	<b>DESCRIPTIONS OF PARTS</b> .....	<b>8</b>
5-1.	NAMES OF PARTS .....	8
5-2.	NAMES OF CUTTER PARTS .....	9
5-3.	FRONT CONTROL PANEL .....	10
5-4.	PAPER DETECTION SENSORS .....	10
<b>6.</b>	<b>DESCRIPTIONS OF FUNCTIONS OF EACH SECTION</b> .....	<b>11</b>
6-1.	PRINTER INITIALIZATION OPERATION .....	11
6-2.	BACK PANEL DIP SWITCH SETTINGS (SETTING THE SCSI ID) .....	11
6-3.	CONNECTING THE SCSI TERMINATOR .....	12
<b>7.</b>	<b>LOADING LABELS/TAGS</b> .....	<b>13</b>
<b>8.</b>	<b>LOADING RIBBON</b> .....	<b>15</b>
8-1.	LOADING RIBBON .....	15
8-2.	REPLACING RIBBON .....	18
<b>9.</b>	<b>CHANGING THE THERMAL HEAD PRESSURE</b> .....	<b>19</b>
<b>10.</b>	<b>TEST PRINTING</b> .....	<b>20</b>
<b>11.</b>	<b>MAINTENANCE</b> .....	<b>21</b>
11-1.	CLEANING THE INSIDE OF THE PRINTER .....	21
11-2.	REMOVING THE INTERRUPTIVE-TYPE CENTER HOLE SENSOR .....	25
<b>12.</b>	<b>REPLACING COMPONENTS</b> .....	<b>26</b>
12-1.	REPLACING THE THERMAL HEAD .....	26
12-2.	REPLACING THE PLATEN ROLLER .....	29
12-3.	REPLACING THE FUSE .....	30
<b>13.</b>	<b>NOTES ON USING CUTTER (CUTTER MODEL)</b> .....	<b>31</b>
<b>14.</b>	<b>TROUBLESHOOTING</b> .....	<b>32</b>
APPENDIX A	BASIC SPECIFICATIONS .....	34
APPENDIX B	INTERFACE .....	35
APPENDIX C	SPECIFICATIONS FOR LABELS AND RIBBONS .....	36
APPENDIX D	LABEL SPECIFICATIONS .....	37
APPENDIX E	THE POSITION OF THE THERMAL HEAD .....	39
APPENDIX F	IMPORTANT ITEMS OF DAILY OPERATION .....	40



# 1. Organization of This Manual

---

Read this manual from the beginning. Read the cautions, notes, and Chapters 3 and 4 in particular very carefully before using the printer.

## Unpacking (Chapter 2)

This chapter instructions for unpacking, and describes the items included with the printer.

## Installation (Chapter 3)

This chapter explains points that require special attention when setting up the printer.

## Notes on Use (Chapter 4)

This chapter provides cautions concerning the handling of the printer and the use of labels/tags.

## Description of Parts (Chapter 5)

This chapter explains the names of the parts of the printer and how to operate the front control panel.

## Functions (Chapter 6)

This chapter explains the initial settings of the printer, and tasks that must be performed each time the labels/tags are replaced.

## Loading Labels/Tags and Ribbon, and changing the thermal head pressure (Chapters 7, 8 and 9)

These chapters explain how to load labels/tags and ribbon, and how to change the thermal head pressure. (Use the specified labels/tabs and ribbon.)

## Test Printing (Chapter 10)

This chapter explains the test printing procedure. Test printing is used to determine whether a problem lies with hardware or software. It is also used to check printing quality.

## Maintenance (Chapter 11)

This chapter explains how to clean each section of the printer. Periodic and proper cleaning of the printer will enable you to use it in optimal condition for a long time.

## Replacing Components (Chapter 12)

This chapter explains how to replace the thermal head, platen roller, and fuse.

## Notes on Using Cutter (Chapter 13)

## Troubleshooting (Chapter 14)

This chapter explains how to resolve problems.

**Note:**

**Understanding references to the "left" and "right" side of the printer**

**References in this manual to the "left" and "right" side of the printer refer to the left and right sides of the printer when viewed from the front of the printer (where the form ejection opening is).**

## 2. Unpacking

---

Detailed illustrations are provided in the "Unpacking Instructions" included in the carton.

Open the outer carton, and remove the accessories and padding material.

Lift the printer up and out of the outer carton.

Carry the printer carefully in both hands with it leaning against your body, and gently place it on a desk or table.

Remove the vinyl bag and the packet of silica gel.

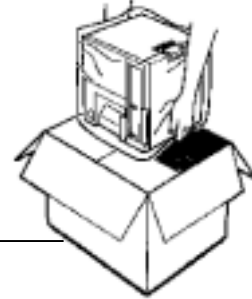

Outer Carton

Fig.1

### **⚠ Caution:**

**The printer weighs approximately 41.8lbs(19kg). When lifting the printer out of the outer carton, hold the printer on the bottom and be careful not to drop it.**

### **Note:**

**The unpacking instructions, the outer carton, and the padding material will be needed if it is ever necessary to repack the printer. Therefore, be careful not to damage them while unpacking the printer, and store them carefully for future use**

### 2-1. Checking the Packing List

**After removing the printer from the carton, make sure that you have all of the items listed below and that they are not damaged.**

- Main Printer Body
- Two ribbon roller gear units
- One ribbon core
- Two roll pressure plates
- One roll holder shaft
- One power cord
- One spare fuse
- One screwdriver
- One Operation Manual (this manual)
- Unpacking Instructions
- One guarantee card
- Two screw locks ( SW ( 400dpi ) only )
- One SCSI terminator
- One set of Printer driver and set up guide
- One output paper guide
- Cleaning cloth

## 2-2 Removing the Protective Devices on the Printer

Unscrew the metal anchor fittings on top of the printer and remove them.

Then, insert the screws back into the printer.

Metal anchor fittings

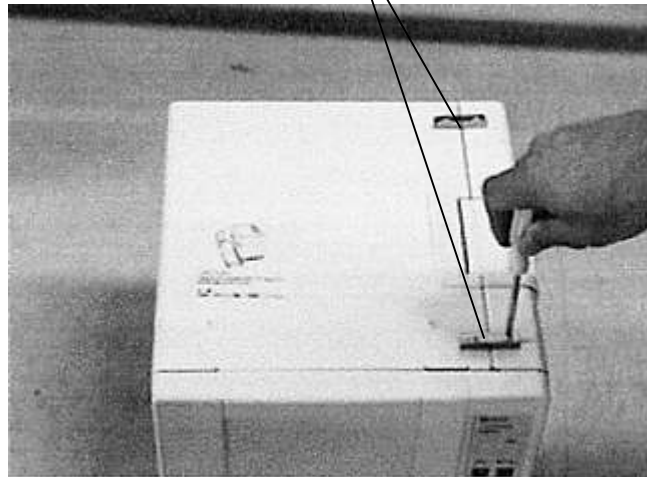

Fig.2

Remove the thermal head protective sheet.

Thermal head  
protective sheet

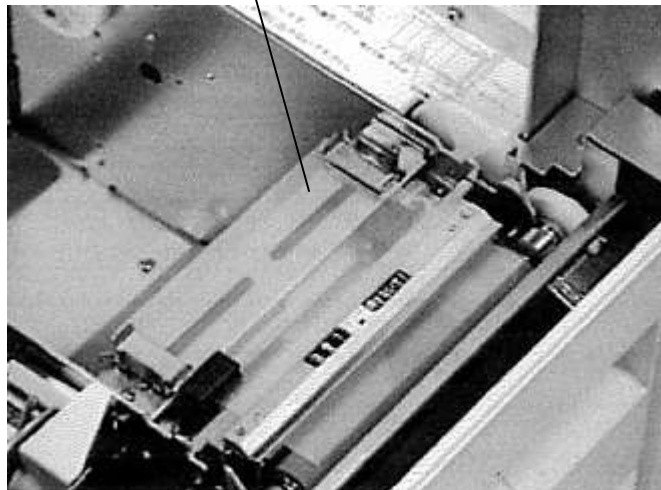

Fig.3

**Note:**

**Store the locking brackets and the thermal head protective sheet, since they will be necessary if you ever need to repack the printer.**

### 3. Installation Environment and Power Supply Connections

#### 3-1.Installation Environment

Select a stable location where the printer can be installed with plenty of room.

In order to get the maximum performance from the printer and in order to ensure safe usage, keep the following points in mind.

In order to make it easier to operate and inspect the printer, allow for plenty of space around the printer. A space of 6"(150mm) or more on the left side of the printer in particular should be kept free of obstacles.

The printer should be used in a dust- and dirt-free environment.

Make sure that the power supply that is input to the printer is not subjected to large, temporary fluctuations in voltage or current, and that the printer is not subjected to broad-band noise or electrostatic discharge.

Install the printer in a location that is not exposed to direct sunlight and is not subjected to rapid changes in temperature and humidity

When connecting the power cord, be sure to connect the ground.

Do not install the printer in a location that is subject to vibration.

Install the printer as far away as possible from radios and television sets.

**⚠ Caution:**

When installing the printer, make sure that at least 6"(150mm) or more area on the left side of the printer is free of obstructions, as shown in the diagram at right. If this clearance is not provided, there is a danger that the printer could fall from the desk or table when the cover is opened.

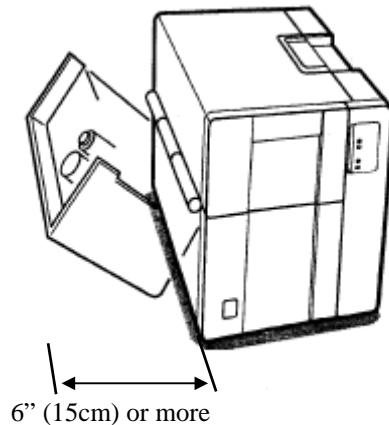

**⚠ Caution:**

When installing or moving the printer, tilt it toward you, then lift after sliding your fingers into the space between the printer and the desk. Be careful not to pinch your fingers.

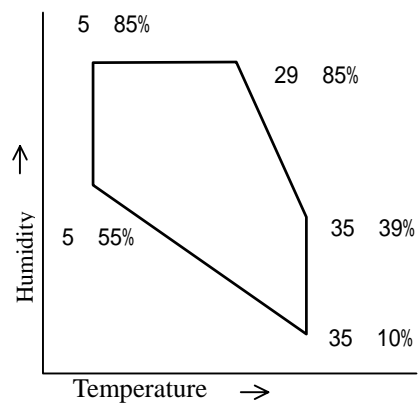

Fig.4

Temperature-Humidity graph

Reference:

The dimensions and weight of the printer are as follows:

Width : 11.4 inches (290mm), Depth : 11.8 inches (300mm)

Height : 12.99 inches (330mm), Weight : 41.8lbs (19kg)

Width : 11.4 inches (290mm), Depth : 11.8 inches (300mm)

Height : 12.99 inches (330mm), Weight : 41.8lbs (19kg)

See the Temperature-Humidity graph for the operating temperature and operating humidity (non-condensing).

### 3-2. Ground and Power Supply Connections

Please observe the following precautions for safe operation.

In order to avoid damage from electrostatic discharge, lightning strikes, leak current, etc., be sure to connect the ground before connecting the power supply.

Do not use a gas pipe as a ground, which could result in a fire, gas explosion, or damage to the equipment.

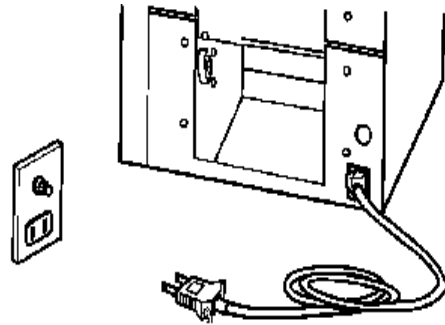

The outlet that is used for the printer should be used only for the printer.

Using a multi-outlet adapter or extension cord can result in a fire or in miss-operation.

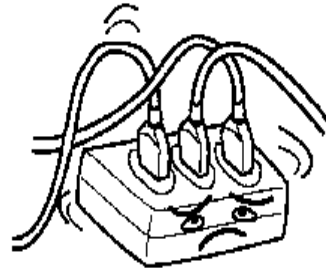

Stepping on or pressing on the power cord can result in an accident, such as a fire or electric shock. Be careful not to crush the cord, especially when moving desks, etc.



Make sure that the power cord is plugged in as far as it will go. Do not use a loose outlet, which can result in a poor connection. Such an outlet could cause a fire. If you will not be using the printer for an extended period of time, unplug the power cord from the outlet.



## 4. Notes on Use

---

### 4-1. Notes on Handling

Do not move or carry the printer while it is printing.

This printer does not have a waterproof construction. Do not spill water or other liquids on it.

Use a shielded cable for the interface cable. If an unshielded cable is used, it is possible that noise will be generated on nearby television sets and radios.

Whenever plugging in any connectors, be sure to turn the power off first.

Whenever plugging in or unplugging the power cord, always grasp the plug, not the cord.

Do not modify the printer or remove any components.

Do not put something before the exhaust hole. Ensure that the exhaust hole remains unobstructed. If the exhaust hose is obstructed, the inside temperature of the printer rises too high, which can result in the damage to the printer.

If you suspect a malfunction or other abnormality (such as abnormal odors, heat, or sounds), turn off the power immediately, unplug the power cord, and contact your service representative. Do not continue to use the printer if it has malfunctioned or if any other abnormality has occurred.

#### Cleaning the Output Slot Paper Guide

Pull out the output slot paper guide and remove the dirt and dust.

### 4-2. Notes on Using Labels/Tags

#### Labels/Tags and Ink Ribbons

Be sure to use the recommended labels and ribbons.

Using non-recommended labels or ribbons can result in problems such as poor print quality and damage to thermal head or other printer components.

Use non-recommended labels or ribbons on your own authority.

Use such an ink ribbon that is 0.39" (10mm) or more wider than the backing paper (though narrower than 0.79" (20mm)). If the backing paper of the labels touches the thermal head directly, the thermal head may be worn which can result in the breakdown of the head.

#### Pre-printed Label

The pre-printed labels that has already frames or lines printed on them may damage the thermal head because of the ink used in pre-printing. When you are going to use pre-printed labels, contact us or your dealer and check whether the labels are suitable. The ink that contains pigment particularly shortens the useful life of the thermal head remarkably. Be sure not to print on the pre-printed portions because the ink will be attached to the heated thermal head which causes the poor print quality.

Note that you can use pre-printed labels only with reflective sensor on DURAPRINTER SW (Usually, the labels sold by NITTO DENKO can not be used with reflective sensor.).

#### Label rolls and ribbon rolls

Store unused label rolls or ribbon rolls in a cool dark place, such as a desk drawer.

### Recommended combination of supplies (size)

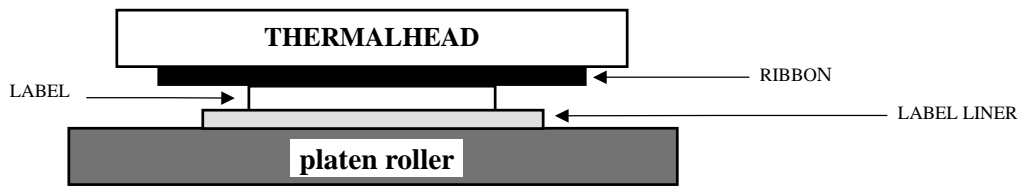

$$\begin{aligned} \text{Label liner width} + 20 \text{ mm} &> \text{Ink ribbon} && \text{Label liner width} + 10 \text{ mm} \\ \text{Label width} + 20 \text{ mm} &> \text{Label liner width} && \text{Label width} + 4 \text{ mm} \end{aligned}$$

The recommended combination of label, label liner and ink ribbon sizes is as shown above. Especially, the difference in width between label liner and ink ribbon gives the following effects (the ribbon is wider than the label liner).

The hardware design of the machine is based on this difference.

- (1) An allowance to transfer the platen roller carrying torque to the ink ribbon is required so as to ensure high running stability of ink ribbon which contacts tight the label and label liner which have different surface friction properties.
- (2) The thermal head must be protected (from wear) from staggering of label edge with respect to liner and from burrs of label liner edges.

### 4-3. Consumables

#### Consumables

The thermal head and platen roller are consumable items. Holding them in reserve is recommended. Those items are user-replaceable.

## 5. Descriptions of Parts

### 5-1.Names of Parts

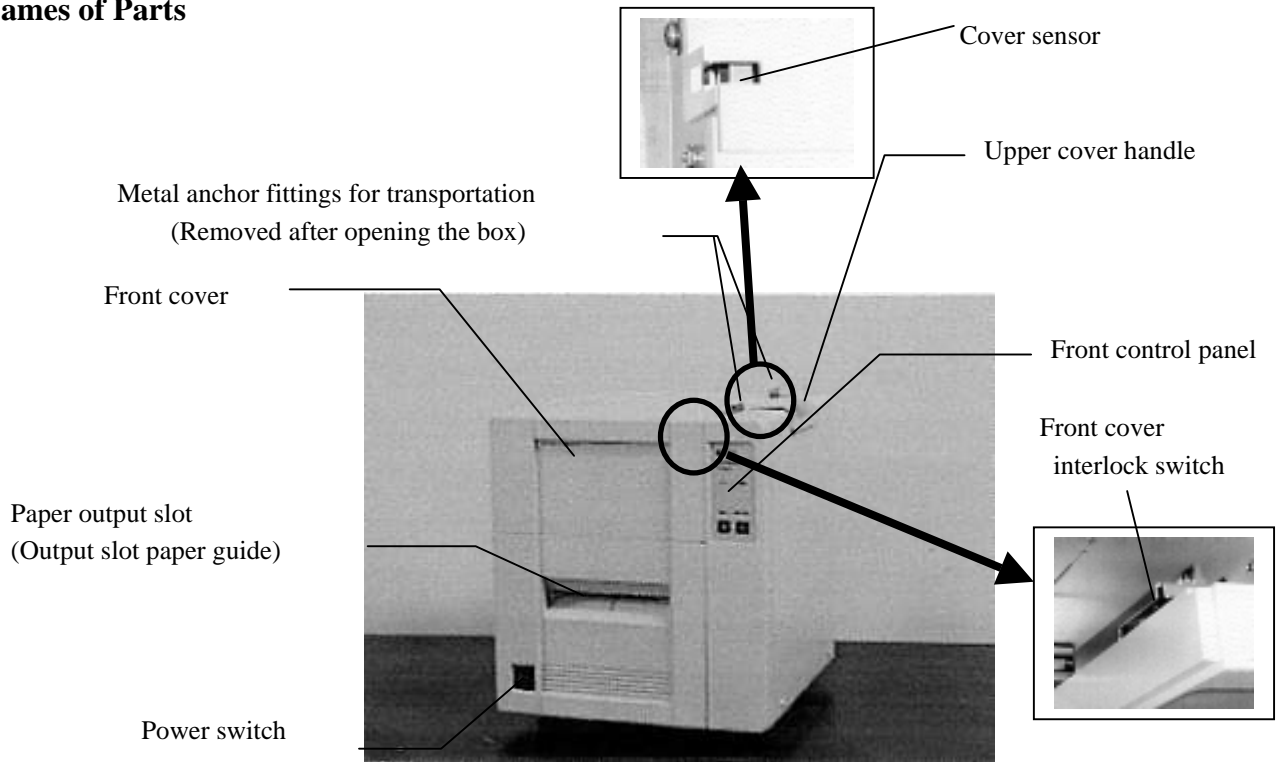

**Note**

**Check whether the output slot paper guide is inserted to the paper output slot.**

**If not, insert the output slot paper guide into the slots at the sides of the paper output slot until it locks.**



Fig.5 Front View

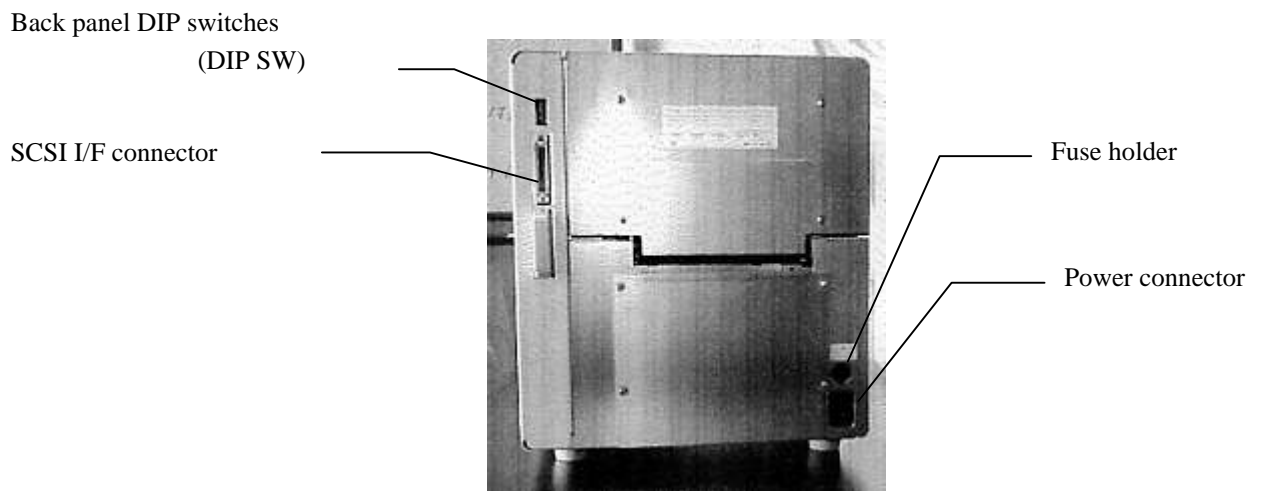

Fig.6 Rear View



## 5-2. Names of Cutter Parts

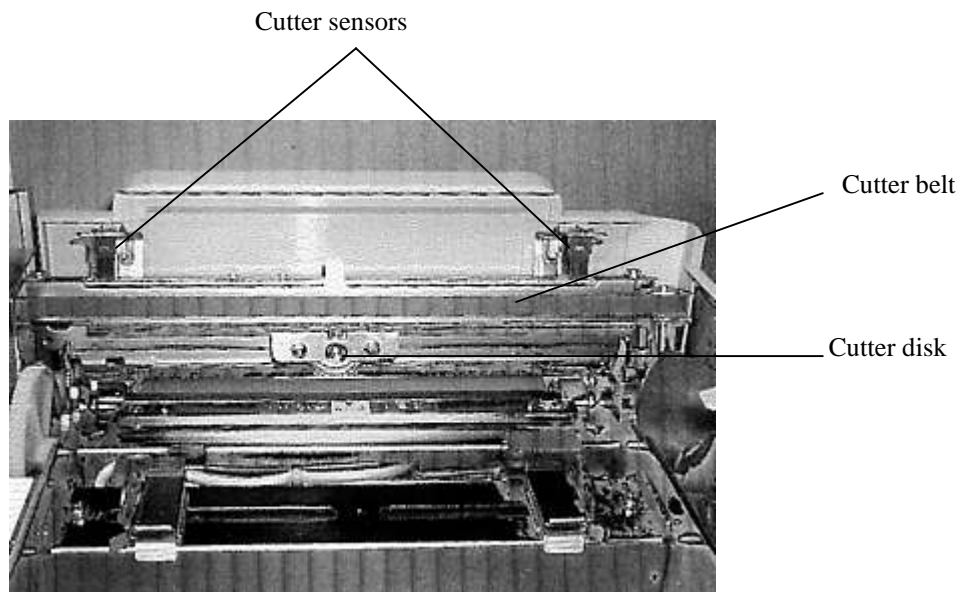

Fig.7

**Note:**

**Do not cut the glue portion of a label. The cutter becomes dull immediately by cutting the glue portion. When the glue portion of a label is cut, clean the cutter disk at once.**

### 5-3.Front Control Panel

Each of the functions of the front control panel is described below.

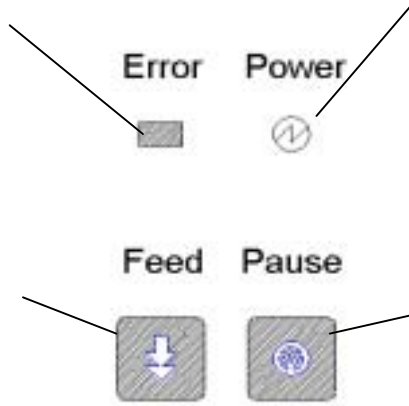

Fig.8

#### Power

This indicates whether printer power is on or off. This lamp lights when the power is on.

#### Error

Off: The printer is in the "ready" state.

Blinking: The printer is in the "paused" state.

On: The printer is in the "error" state. The printer beeps continuously while it is in this state.

#### Pause

Use this switch to select between the "ready" state and the "paused" state. Each time this switch is pressed, the Error lamp switches between blinking and being off.

#### Feed

Each time this switch is pressed, the printer feeds forward one page of labels.

### 5-4.Paper Detective Sensors

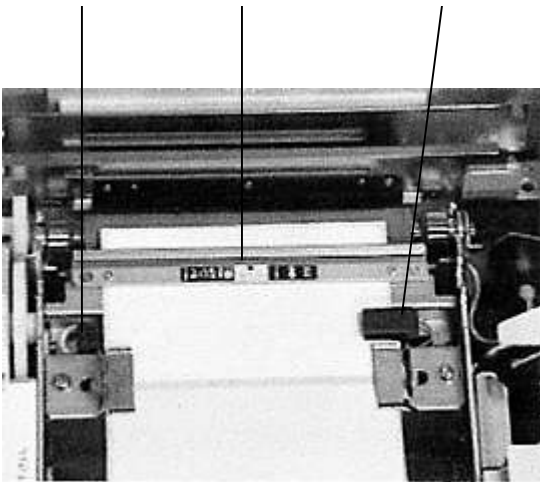

Fig.9

#### Reflective sensor (movable)

This sensor can detect "eye" marks on the back of forms, and notches in the edge of forms. (This sensor provides paper feed accuracy that is inferior to that of sensors and described below.)

#### Interruptive-type center sensor (fixed)

This sensor detects gaps between forms (breaks in the backing paper) and detects center holes. (This sensor provides the best paper feed accuracy.)

#### Interruptive-type form edge sensor(movable)

This sensor detects gaps between forms (breaks in the backing paper), and notches in the edge of forms. (This sensor provides paper feed accuracy that is inferior to that of sensor above.)

Adjust the position of the sensor so that labels pass

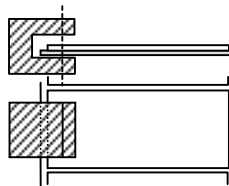

## 6. Description of Functions of Each Section

### 6-1. Printer Initialization Operation

When the power is turned on, after the hardware completes initialization, the printer performs a thermal head check (checking for disconnected wires) after the memory test. While the thermal head check is in progress, the Error LED flashes and the printer beeps intermittently. When the Error LED turns off and the beeping stops, the printer has completed the initialization operation.

### 6-2. Setting the DIP Switches on the Rear of the Printer (Setting the SCSI ID)

#### 1. Setting the SCSI ID

The SCSI ID is set through the DIP switches on the rear of the printer.

When the printer is shipped from the factory, the SCSI ID is set to "2".

When connecting just the printer, or when "2" is not the SCSI ID of any other SCSI device, there is no need to change the setting of the SCSI ID on the printer.

If the SCSI ID of another SCSI device is also "2," it is necessary to set the SCSI IDs so that each device has a unique SCSI ID.

**Note**

Although SCSI IDs can range from 0 to 7, "7" is frequently used by the SCSI board as its own ID.

SCSI ID correspondence table

DIP SW	1	2	3
SCSI ID NO. 0	OFF	OFF	OFF
1	OFF	OFF	ON
2	OFF	ON	OFF
3	OFF	ON	ON
4	ON	OFF	OFF
5	ON	OFF	ON
6	ON	ON	OFF
7	ON	ON	ON

Factory setting

#### 2. Setting the Parity

DIP SW 4 ON: Parity ON

Factory setting

DIP SW 4 OFF: Parity OFF

#### 3. Forms Mode during Test Printing

DIP SW 6 OFF: Label Marker Detection

DIP SW 6 ON: Continuous Paper

Factory setting

#### 4. Paper Cut with Feed Switch (Cutter model)

DIP SW 6 OFF: No Cut

DIP SW 6 ON: Cut

Factory setting

#### 5. Miscellaneous

DIP SW 5 OFF: Other than Windows XP

Factory setting

DIP SW 5 ON: Windows XP

---

### 6-3.Connecting the SCSI Terminator

If the only SCSI device that is connected to the computer is a printer, connect the SCSI terminator to the printer.

If multiple SCSI devices are connected to the computer, connect the SCSI terminator to the last device in the chain of SCSI devices connected to the computer.

**Note:**

**When turning on the power, turn on each of the SCSI devices first, including the printer.**

**Wait for about 10 seconds before you turn on the computer.**

**When turning the power off, turn off the computer first, and then turn off the SCSI devices.**

Terminator

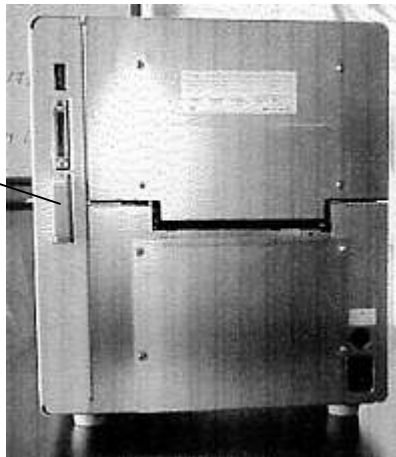

Fig.10

## 7. Loading labels/Tags

---

Place the label/tag roll on the roll holder plate.

Roll holder plate

Roll holder shaft

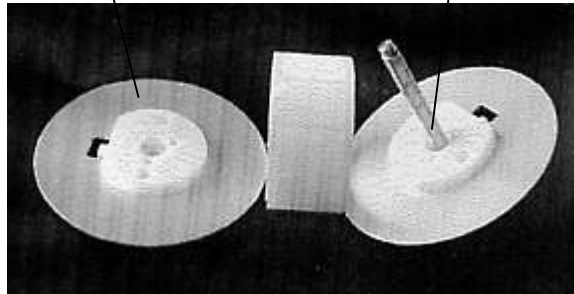

Label/Tag roll

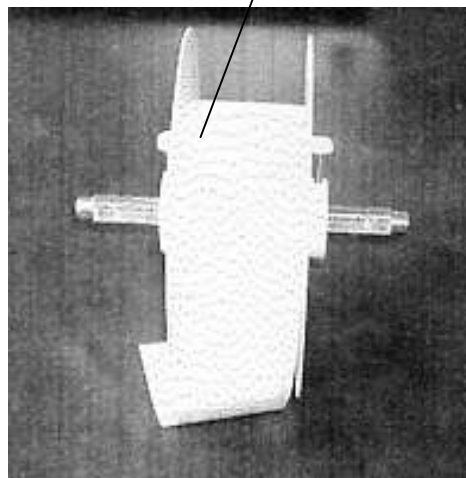

Fig.11

- The roll holder shaft has a scale on it. Line up the label/tag roll so that it is positioned at the center of the scale. Tighten the screw knob to fix the roll paper plates as it presses the flat surface (the surface without scales on it) of the roll holder shaft.

Open the upper cover, and place the left and right ends of the roll holder shaft in the shaft holders on the printer.

**Note:**  
**When loading or replacing labels/tags, the roll holder plates may fall off of the core of the label/tag roll. Be sure to hold the roll holder plates in place with both hands when loading the labels/tags into the printer. Dropping one of the roll holder plates on the thermal head can damage the head.**

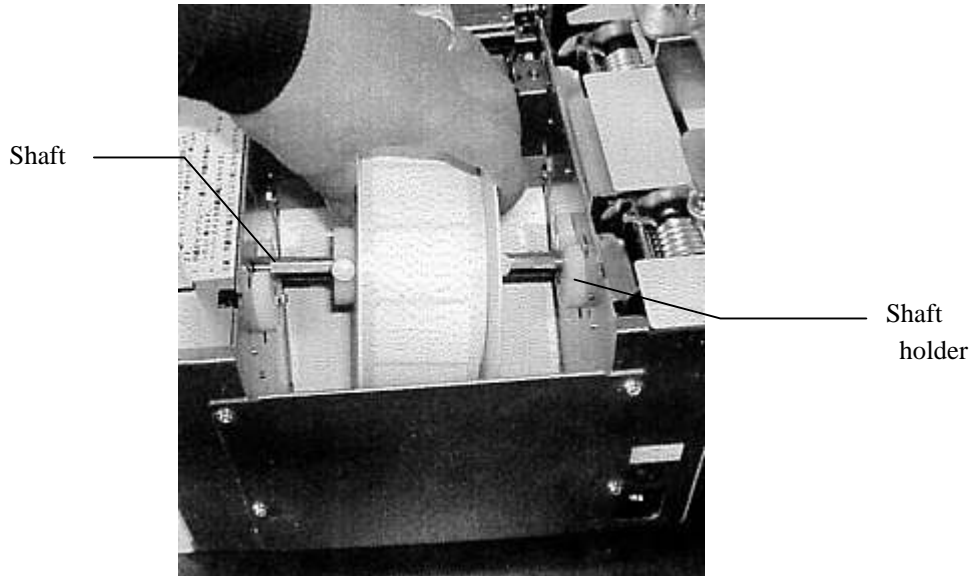

Fig.12

Spread the paper guides wider than the width of the label, and then load the labels/tags by threading them through the paper guide and the sensors, until the labels/tags reach the platen roller. Push the paper guides towards the center until they touch both edges of the label. Close the top cover.

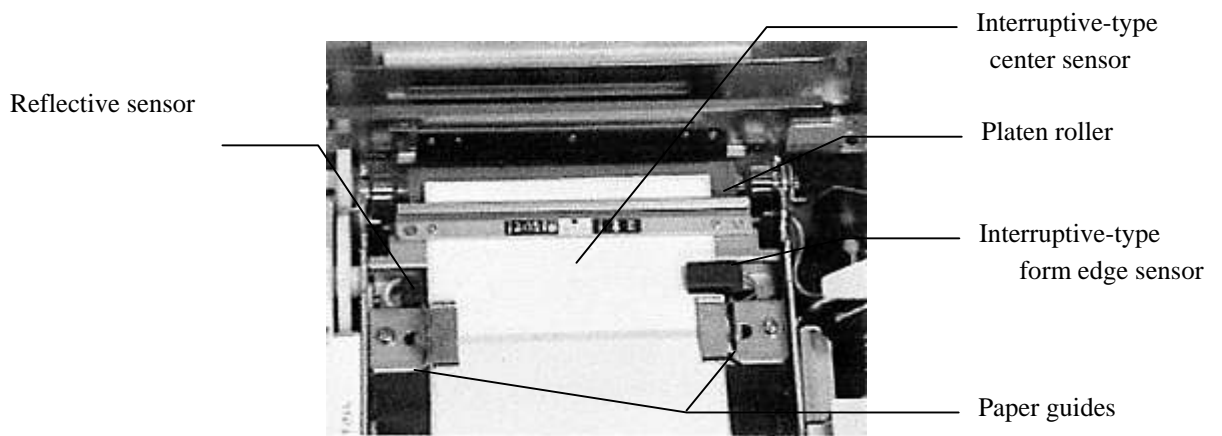

Fig.13

## 8. Loading Ribbon

---

### 8-1.Loading Ribbon

Insert the ribbon roller gear unit in a ribbon core. Position the ribbon core at the center of the ribbon roller gear unit.

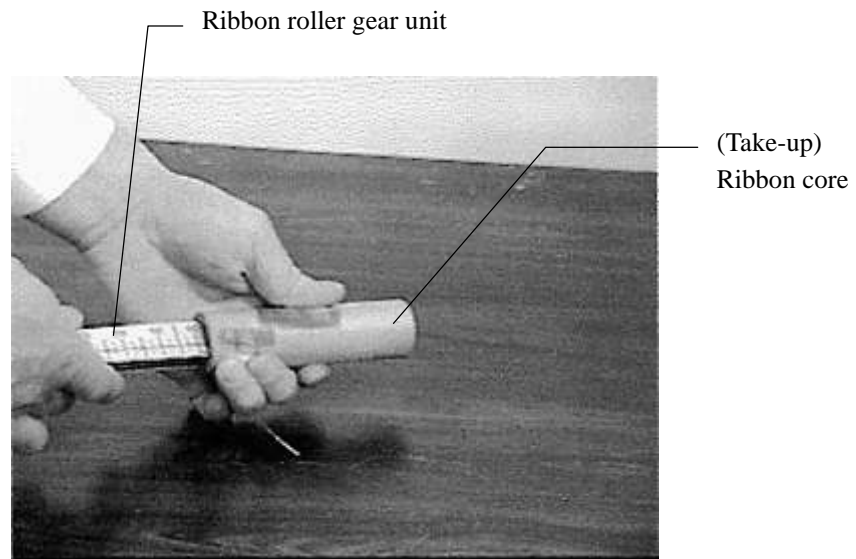

Fig.14

Open the top cover of the printer.

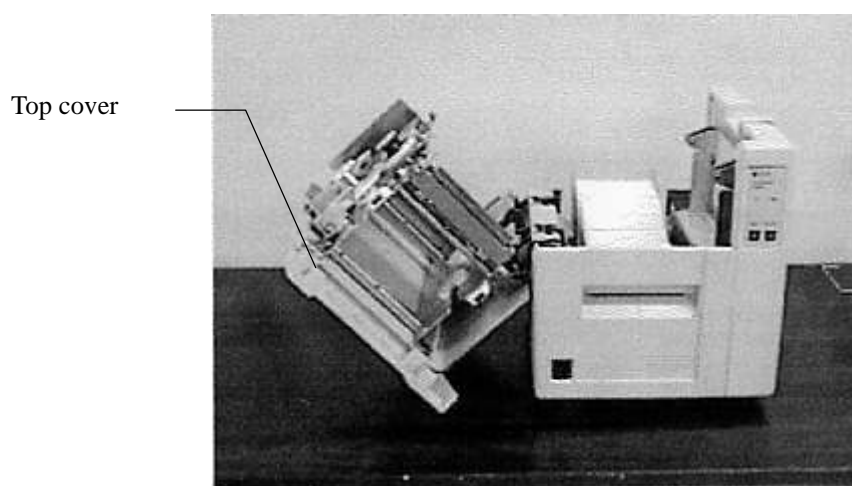

Fig.15

Insert the ribbon roller gear unit in a new ribbon (supply ribbon) core so that the new ribbon core is positioned at the center of the ribbon roller gear unit, just as in step .

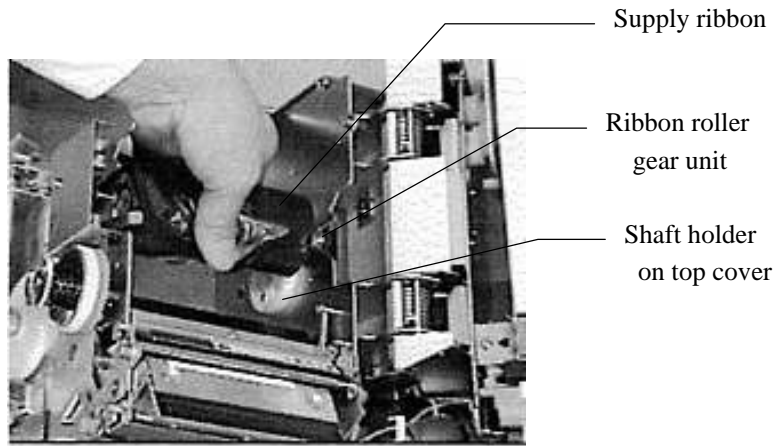

Fig.16

Take the ribbon roller gear unit with a ribbon core on it that was prepared in step , and place it in the v-shaped notches on the top cover. Then lift up the leader tape on the new ribbon (supply ribbon) and attach it to the ribbon core (take-up ribbon core).

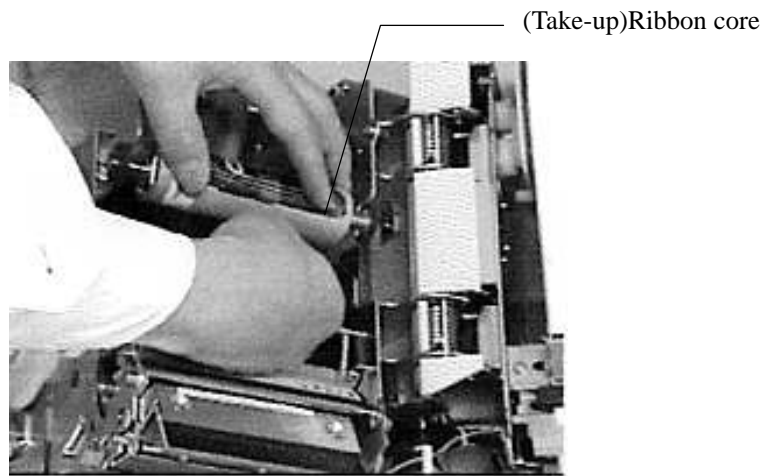

Fig.17

**⚠ Caution**

The thermal head may be hot. When loading a ribbon, be careful not to touch the thermal head.

**⚠ Caution Print head is hot**

This warning label is located near the thermal head.



Push the roller gear unit (the one with the ribbon core on it and the leader tape attached) into the take-up ribbon shaft holder on the top cover until the roller gear unit clicks into place.

Take-up ribbon  
shaft holder

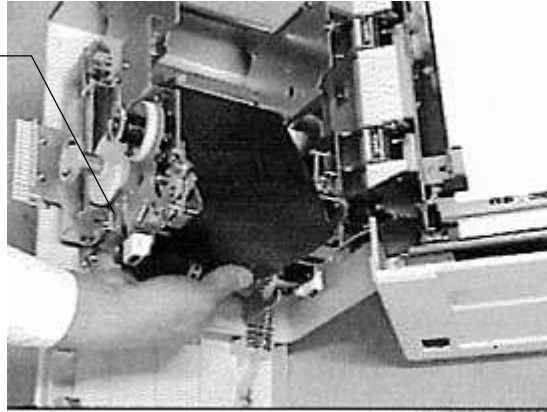

Fig.18

Turn the take-up knob counterclockwise to take up the slack in the ribbon.

Take-up knob

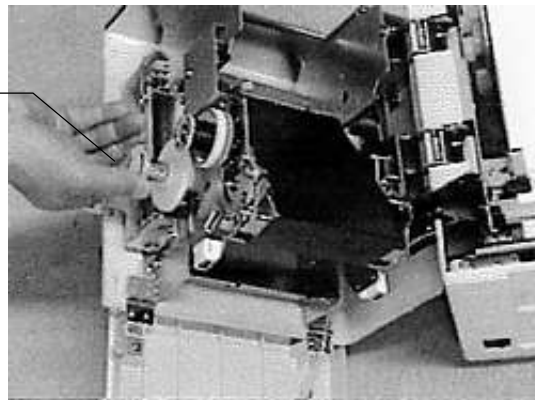

Fig.19

## 8-2.Replacing Ribbon

Grasp the used ribbon, and pull the ribbon roller gear unit out of the take-up ribbon shaft holder on the top cover of the printer.

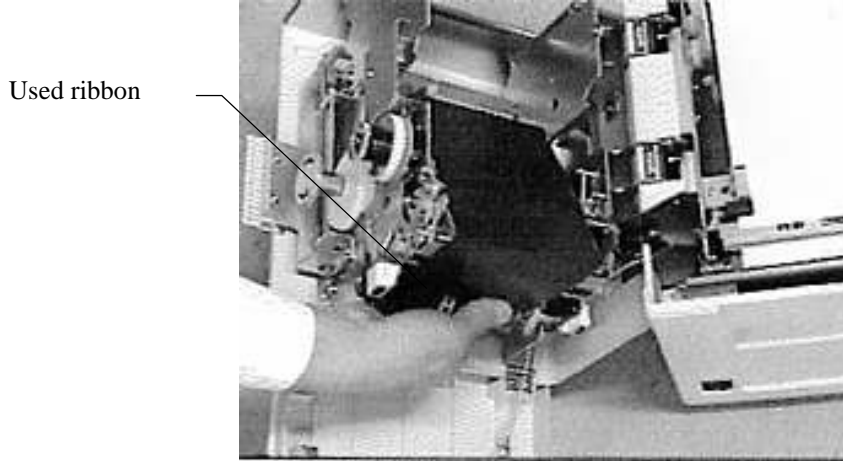

Fig.20

Pull out the ribbon roller gear unit from the used ribbon.



Fig.21

Use the empty supply ribbon core as the next take-up ribbon core.

**Note:**

**If the front cover is opened and closed frequently while the ribbon take-up diameter is large, the ribbon that has been taken up may begin to lean too much to one side, making it difficult to remove when replacing the ribbon.**

**In this event, pull the ribbon back towards the center and then remove it.**

## 9. Changing the Thermal Head Pressure

**⚠ Caution**

Turn the power off before performing this procedure.

Note that the thermal head may still be hot even if the power has been turned off.

**⚠ Caution** Print head is hot.

This warning label is located near the thermal head.

If the labels are less than 2"(50mm) wide, hold down the heating element side of the thermal head with your finger and insert the thermal head pressure changing plate under the two discs.

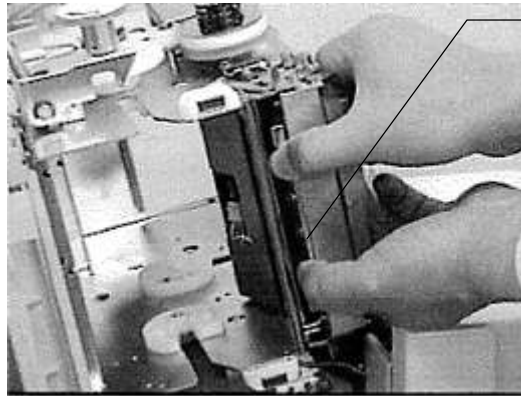

Thermal head pressure changing plate

Fig.22

If the labels are 2"(50mm) or more wide, hold down the heating element side of the thermal head with your finger and remove the thermal head pressure changing plate under the two discs.

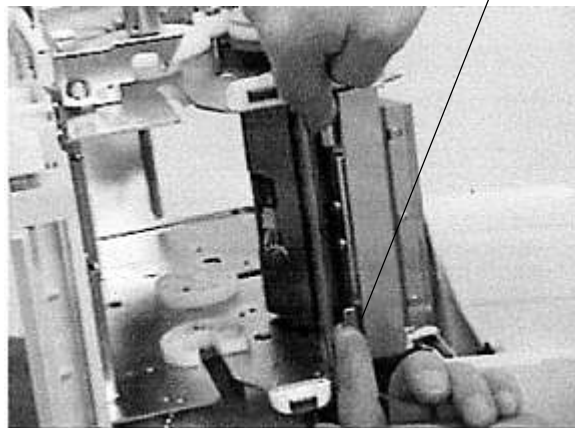

Thermal head pressure changing plate

Fig.23

# 10. Test Printing

The test printing procedure is described below. When installing the printer, always be sure to perform a test print once before connecting the printer to the computer.

- Confirm that the form mode is "continuous form" mode. (DIP switch 6 on the back of the printer should be "ON.")
- Load 3.94"(100mm)-wide continuous forms (normal paper of coated paper) and 4.72"(120mm)-wide ribbon(Wax/resin type) into the printer.
- To execute a test print, turn on the power while holding down the "Feed" button on the front panel.
- To end the test, press the "Pause" switch and then turn the power off.
- At the start of the test printing, the head discontinuity is checked. The head check pattern is printed on the first page, and demo printing patterns are printed on the second and subsequent pages.
- Turn off the DIP switch 6 on the back of the printer.

### Test printing examples

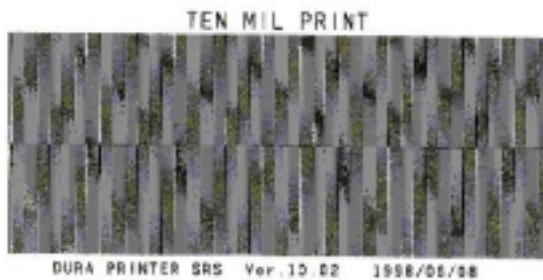

### Demo printing pattern

# 11. Maintenance

---

In order to keep the printer operating in peak condition for a long time, be sure to perform the maintenance and inspections described below. If these maintenance and inspection procedures are not performed, the printer will not be covered by its warranty.

<b>⚠ Caution:</b>
<b>When performing maintenance and inspections, be sure to turn both the printer and the computer off, and disconnect the power cords from the power outlets.</b>
<b>Use the cleaning cloth included in the box, isopropyl alcohol, methanol, or ethanol to clean the thermal head, platen rollers, and form sensors. Using other solvents could damage the components. Handle isopropyl alcohol and methanol carefully, as both are flammable. Also, do not attempt to clean the thermal head while it is hot.</b>

<b>Note</b>
<b>Use the cleaning cloth included in the box or a clean and previously unused cloth when cleaning. Never use chemical cleaning cloths.</b>
<b>If you will touch the inside of the printer, remove any precious metals or gloves from your hands. Be careful not to scratch the thermal head with any metallic buttons, rings, bracelets, or other metallic objects.</b>
<b>Do not apply any lubricants to any part of the printer. Lubricants are applied at the factory, and do not need to be applied by the user.</b>
<b>Do not spray any solvent, cleaning solution, or anything else onto, into or around the printer. If spray gets into the printer, damage may result.</b>

## 11-1 Cleaning the Inside of the Printer

<b>⚠ Caution</b>
<b>Be certain to turn the power off first.</b>

The inside of the printer should be cleaned after every 985ft(300m) of labels. (In other words, after using one standard 985ft ribbon.)

Clean the following locations:

Paper guide, platen roller, paper sensors, ribbon peeler (the stainless cover), ribbon take-up bar, and thermal head.

Turn the power off, disconnect the power cord from the power outlet, open the top cover of the printer, remove the labels and ribbon, and then clean the locations listed above with a clean cloth dampened with isopropyl alcohol, methanol, or ethanol.

### Cleaning the Paper Guide

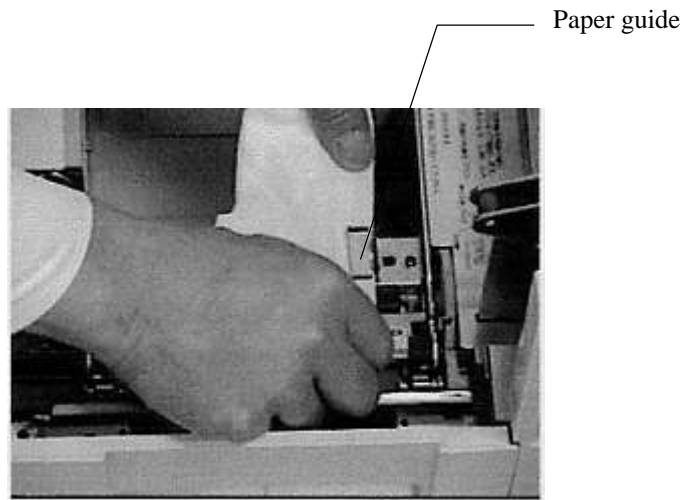

Fig.24

### Cleaning the Platen Roller

Clean while turning the gears manually.

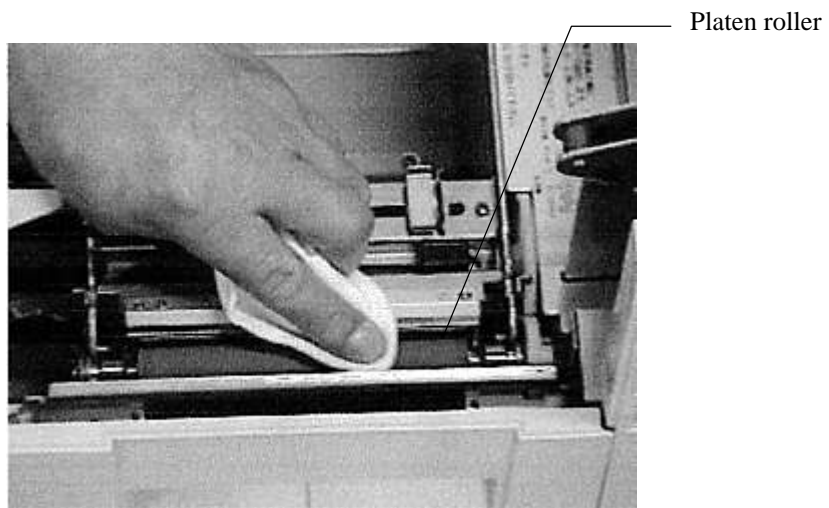

Fig.25

### Cleaning the Paper Sensors

The sensor located between the paper guide and the platen roller through which the labels pass is the Interruptive-type sensor. Pass a cloth dampened with alcohol through the region where the labels pass and then move the cloth back and forth several times to clean the sensor.

Clean the surface of the reflective sensor.

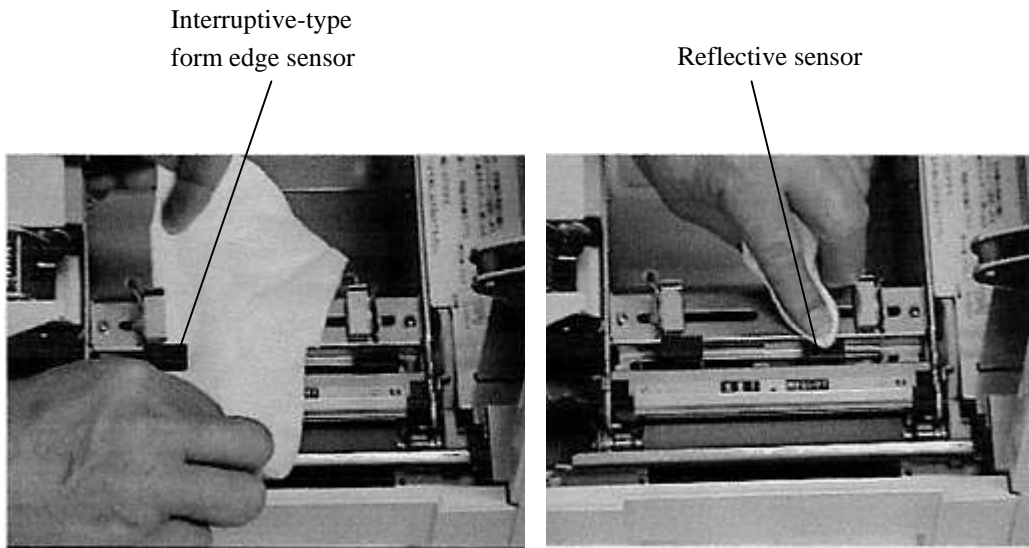

Fig.26

### Cleaning the Ribbon Peeler and the Ribbon Take-up Bar

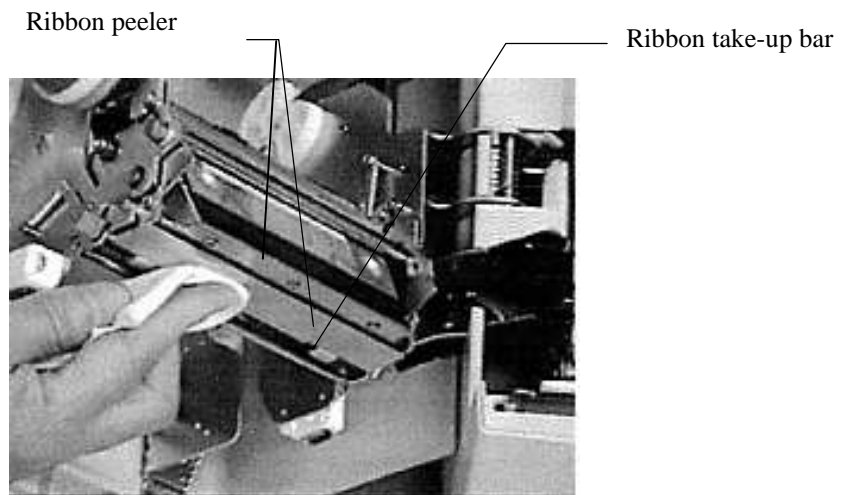

Fig.27

### Cleaning the Thermal Head

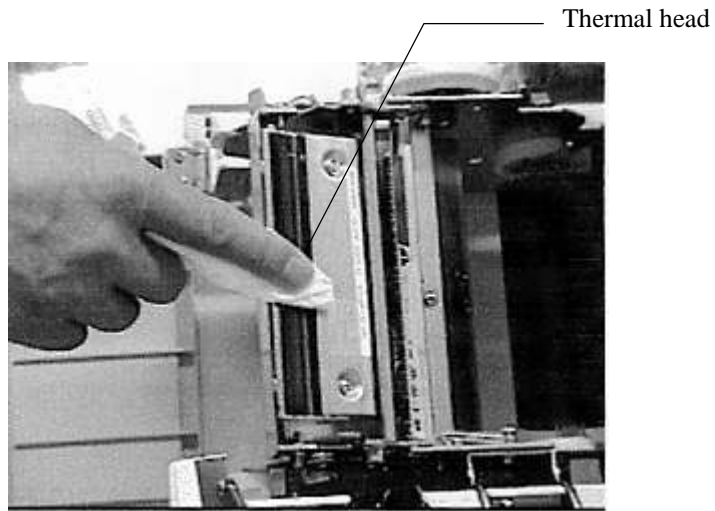

Fig.28

<b>⚠ Caution</b>
Note that the thermal head may still be hot even if the power has been turned off.
<b>⚠ Caution Print head is hot.</b> This warning label is located near the thermal head.

### Cleaning the Cutter (Cutter Model)

Clean the cutter disk with a cotton swab dampened with isopropyl alcohol, methanol, or ethanol.

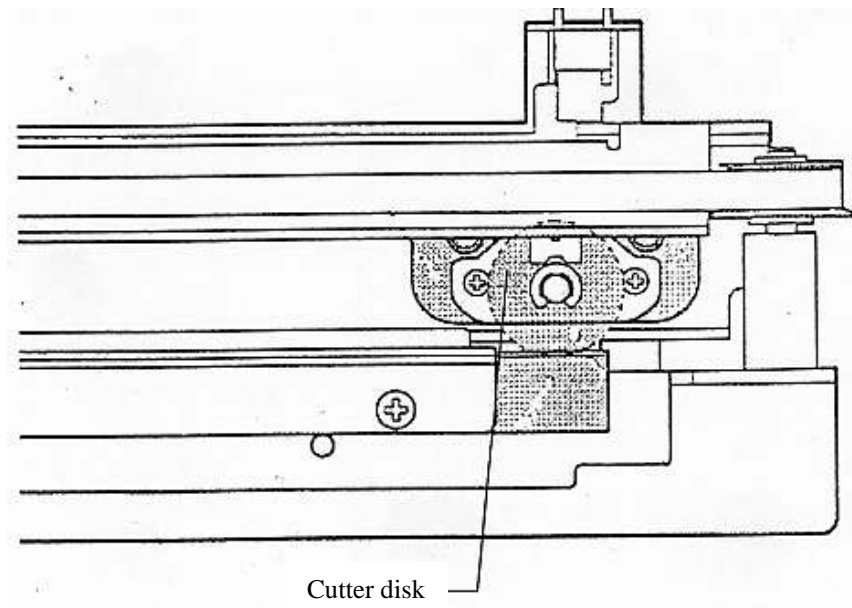

Fig.29



---

## 11-2. Removing the Interruptive-type Center Sensor

If a label accidentally sticks to the bottom portion (tunnel portion) of the Interruptive-type center sensor, remove the Interruptive-type center sensor as described below and remove the label.

Use a flat-blade screwdriver to remove the left and right screws holding the Interruptive-type center sensor in place.

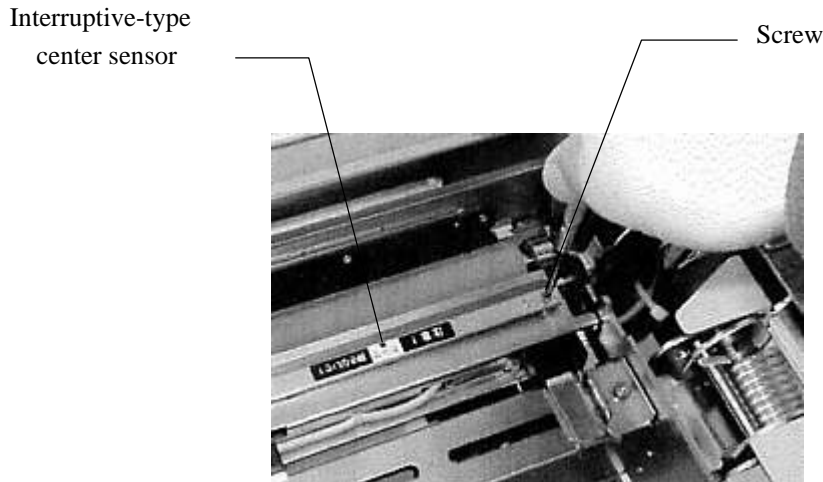

Fig.30

Remove the Interruptive-type center sensor unit and then remove the label.

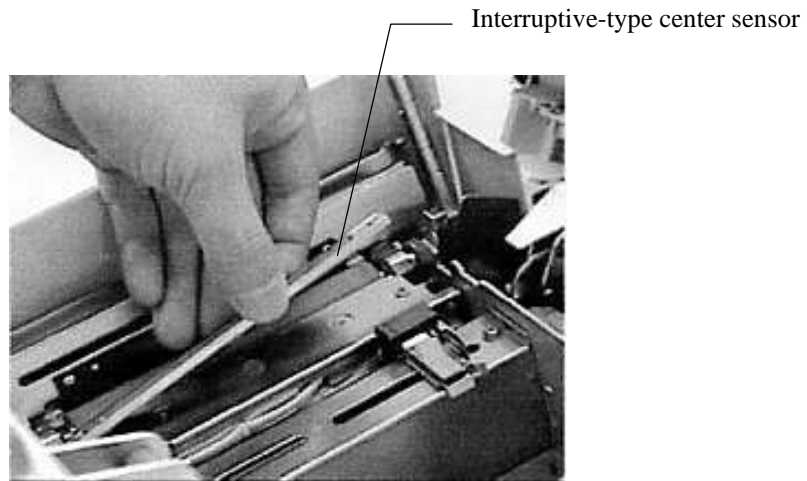

Fig.31

Re-attach the Interruptive-type center sensor unit and then use a flat-blade screw driver to tighten the left and right screws.

## 12. Replacing Components

---

### 12-1.Replacing the Thermal Head

After being used for a long period of time, the thermal head may reach the end of its operational life, which will manifest itself through a deterioration in print quality resulting from broken wiring in the thermal head (resulting in white vertical lines), blurred bar codes and text, etc. It is then necessary to replace the thermal head in order to maintain the print quality. The thermal head replacement procedure is described below. (The thermal head is considered to be a consumable component.)

**Note**

**The thermal head is considered to be a consumable component.  
Holding them in reserve is recommended.**

Turn the power switch off, open the top cover, and remove the ribbon on the take-up side.

**⚠ Caution:**

**Note that the thermal head may still be hot even if the power has been turned off.**

**⚠ Caution Print head is hot.**

**This warning label is located near the thermal head.**

Press the left and right release levers, and remove the thermal head.

Release levers

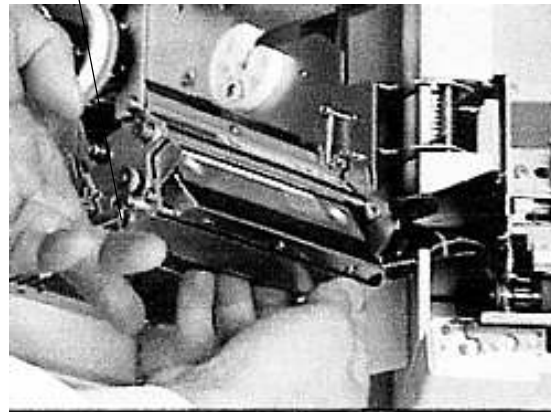

Fig.32

Disconnect the two connectors on the thermal head, and then remove the thermal head from the printer.

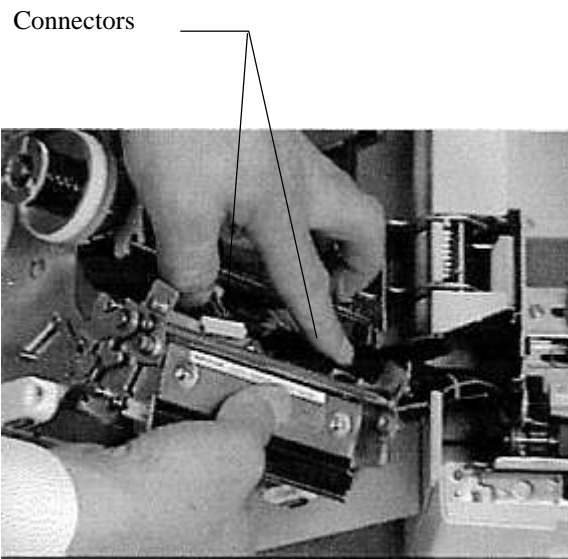

Fig.33

Being careful not to scratch it, connect the connectors to the new thermal head.

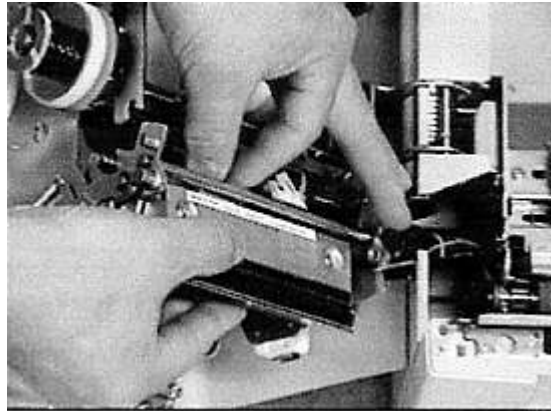

Fig.34

**Note:**

**When connecting and disconnecting the connectors, make sure to match the polarity and the positioning of the connectors first. Also, be careful not to bend the connector pins.**

After setting the thermal head bracket into the guide holes in the printer, push the thermal head in until it locks in place.

Be careful not to bend the ribbon peeler.

Guide holes in printer

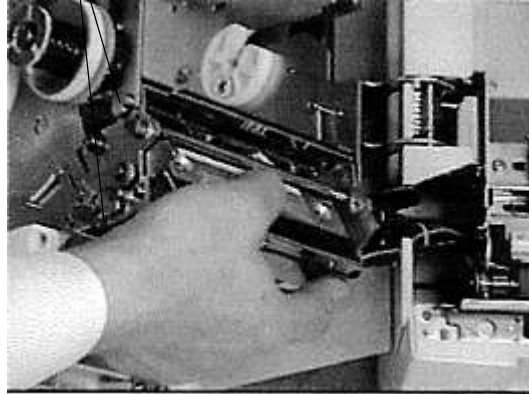

Fig.35

**Note:**

- **When replacing the thermal head, be careful not to scratch the new thermal head, or get it dirty.**
- **When replacing the thermal head, be careful not to touch the heating element surface with your fingers. Sweat on your fingers will contain salt, which could corrode the protective film on the surface of the thermal head. If you do accidentally touch the surface, clean it immediately.**
- **After installing the thermal head, wipe it gently.**

## 12-2. Replacing the Platen Roller

After being used for a long period of time, wear on the platen roller may result in a deterioration in print quality, such as blurred bar codes and text, etc. It is then necessary to replace the platen roller in order to maintain the print quality. The platen roller replacement procedure is described below. (The platen roller is considered to be a consumable component.)

Press down the release levers at the left and right ends of the platen roller and remove the platen roller. (Remove the end with the gears first.)

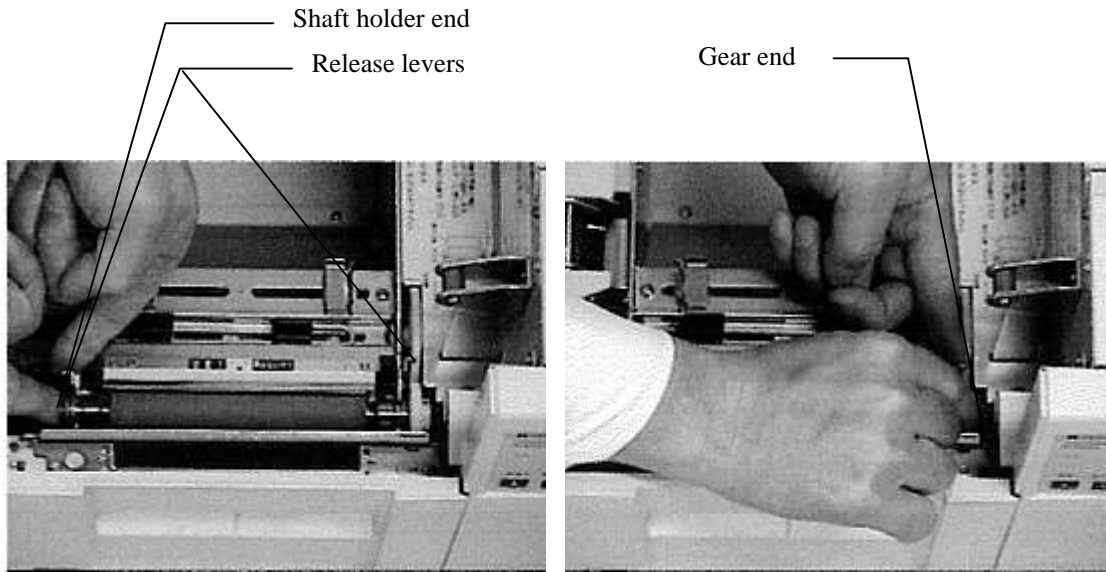

Fig.36

Install the new platen roller.

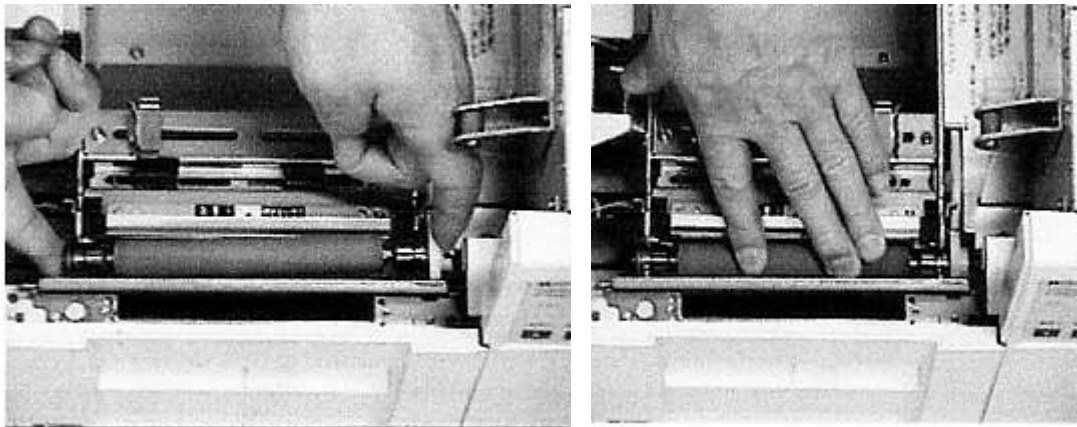

Fig.37

---

### 12-3.Replacing the Fuse

Turn the fuse holder cap counterclockwise with a coin or a flat-blade screwdriver and pull out the fuse.

Remove the old fuse and push a new fuse into place. (One replacement fuse is included with the printer.)

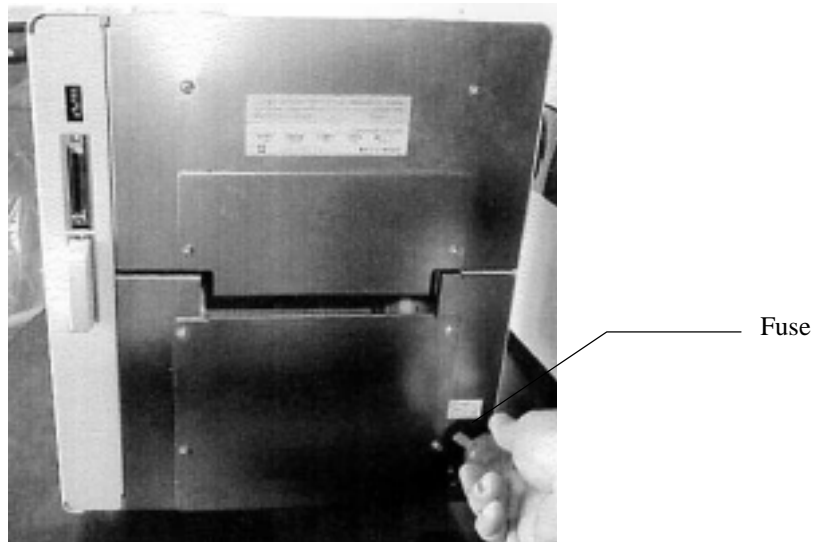

Fig.38

**⚠ Caution**

Replace the fuse only with a fuse of the same type and ratings. Using a different type of fuse could result in a fire. The ratings for the fuse is 3.15A time lag, 250V AC.

## 13. Notes on Using Cutter ( Cutter Model )

### Cutting the Labels with Glue

Be sure to cut the backing paper part between labels when using the labels with glue.

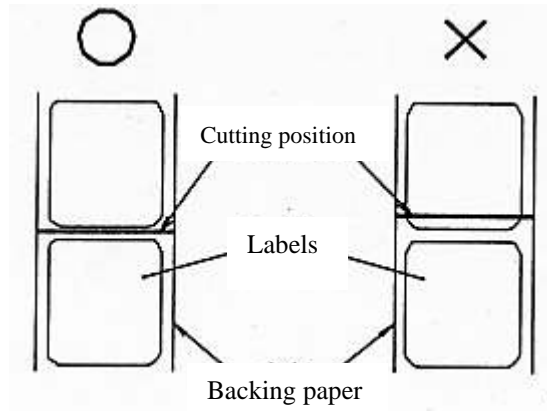

Fig.39

When the cutting can not be performed on the backing paper portion, make an adjustment to the cut position with the position corrective mechanism of the printer driver.

**Note**

**The cutter becomes dull immediately by cutting the glue portion of the label.**

**When the glue portion of a label is cut, clean the cutter disk at once.**

**Do not cut the continuous paper labels without the back paper portion.**

### Cutting the Perforated Labels

Cutting is prohibited within the 0.08" (2mm) region before and after the perforation. Be sure to cut other portion of the backing paper.

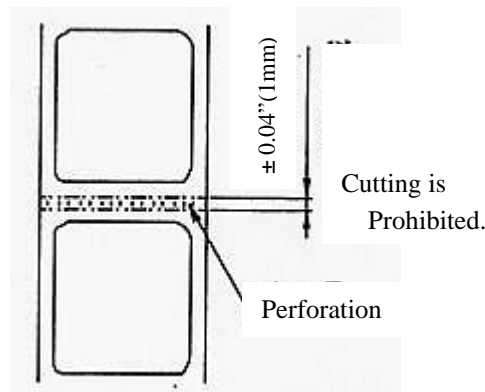

Fig.40

### The Thickness of the Paper that the Cutter can Cut

The cutter can cut the paper of 0.003" (0.08mm) to 0.010" (0.25mm) thick.

### - Replacing the Cutter -

The cutter becomes dull with time. In this case make contact to your dealer.

# 14. Troubleshooting

This chapter explains what to check when the printer does not operate correctly, and what steps to take to resolve the problem.

Symptom	Considerable Cause	Remedy
Test printing does not work.	<ul style="list-style-type: none"> <li>The "Feed" switch is not pressed.</li> </ul>	<ul style="list-style-type: none"> <li>Turn on the power while pressing the "Feed" switch.</li> </ul>
The printer does not print at all. (The form is not fed.)	<ul style="list-style-type: none"> <li>The power switch is not ON.</li> <li>You have turned on the printer after the personal computer.</li> <li>The communication cable has connection problems, or is disconnected.</li> <li>The printer is not ready.</li> <li>A SCSI board is not selected as the printer.</li> </ul>	<ul style="list-style-type: none"> <li>Turn on the power cable or power switch.</li> <li>Turn on the printer first, and, after the buzzer ceased to sound, turn on the personal computer.</li> <li>Re-connect the communication cable or replace it.</li> <li>Press "Pause" and then "Error" LED goes off.</li> <li>Set trspX-Y-Z (X,Y and Z stands for a number respectively.) for the "Print Port" on the "advanced" tab of Printer Driver.</li> </ul>
A paper jam occurs.	<ul style="list-style-type: none"> <li>The position of the leading edge of the paper is wrong.</li> <li>The length is not measured correctly or the stored length data are destroyed.</li> <li>The paper size is not correct.</li> <li>The selection of the paper is wrong.</li> <li>The paper sensor is not selected appropriately.</li> <li>The paper sensor is in the wrong position.</li> <li>The paper guides are in the wrong position.</li> </ul>	<ul style="list-style-type: none"> <li>Set the paper as it covers the platen roller.</li> <li>Open the printer driver and perform the measurement again.</li> <li>Designate the paper size on the printer driver.</li> <li>Equate the paper mounted on the printer and the paper type selected on the application software.</li> <li>Use the paper sensor designated by the printer driver.</li> <li>Interruptive-type paper edge sensor: Move the sensor where its notches catch the paper.</li> <li>Reflective-type paper sensor: Set the sensor to the eye mark on the back side of the paper.</li> <li>Set the paper guides so that they hold the both edges of the paper.</li> </ul>
The buzzer remains sounding.	<ul style="list-style-type: none"> <li>The thermal head is worn out.</li> <li>When the cover sensor is closed and the front cover interlock switch is OFF, the head breaking error is assumed.</li> <li>The buzzer may sound when PSU (power supply) is under abnormal conditions.</li> </ul>	<ul style="list-style-type: none"> <li>Replace the thermal head.</li> <li>Check the front cover interlock switch.</li> <li>PSU needs replacement or repair.</li> </ul>



## DURAPRINER SW

The printer does not print while the paper is fed.	<ul style="list-style-type: none"> <li>• The ribbon is installed backwards or the ribbon is not installed.</li> <li>• The selection of the supplied material type or that of the density is wrong.</li> </ul>	<ul style="list-style-type: none"> <li>• Properly re-install the ribbon, so that the inked side faces out (the surface).</li> <li>• Change the selection of the supplied material type or the density to make them appropriate.</li> </ul>
The blurred or creased printing occur.	<ul style="list-style-type: none"> <li>• The supplied material has been changed.</li> <li>• The supplied material other than the specified one is used.</li> <li>• The platen roller is worn out.</li> <li>• The thermal head is worn out.</li> <li>• The ribbon is creased.</li> <li>• The ribbon is not installed straight.</li> <li>• The selection of the supplied material type, the density, or the print speed is wrong.</li> </ul>	<ul style="list-style-type: none"> <li>• Change the Print Density setting to a higher value.</li> <li>• Change over to the specified supplied material.</li> <li>• Replace the platen roller.</li> <li>• Replace the thermal head.</li> <li>• Re-install the ribbon without creasing it.</li> <li>• Re-install the ribbon properly.</li> <li>• Change the selection of the supplied material type, the density, or the print speed to make them appropriate.</li> </ul>

### Error Display Lamps

Through the small hole on the right side cover, you can see seven segments of LED lamps on the electronic board inside the printer. These lamps indicate the status of the printer and the displayed number is useful to identify the error. When you make an inquiry to us about the mal-function of your printer, please inform us of the displayed number together with the problem.

Displayed No.	The status of the printer
0	No error
1	Paper jam
2	Paper end
3	Ribbon end
4	Thermal head overheating
5	Head open
7	Failure of measuring the length
8	Head broken or cover interlock switch OFF
4 1	Cutter jam or cover interlock switch OFF
6 4	SCSI error
7 1	Printer operating
7 2	Wrong parameters
7 3	Page data not designated
7 4	Operation data not designated
7 5	Image data not designated
7 6	Leading edge alignment not performed
7 7	The cover is open.
7 8	Reset mode
7 9	Pause
9 0	RAM error
9 1	ROM error

## APPENDIX A Basic Specifications

	SW ( 400dpi )	Remarks
1.Printing method	Thermal transfer method	
2.Dot density	400dpi(15.75dot/mm)	
3.Printing speed	0.5"/sec to 4.0"/sec	
4.Max. printing width	3.84" (1536dot)	
5.Max. printing height	12.00" (4800line)	
6.Page width	0.98" to 4.33" (25 to 110mm)	Including the backing paper
7.Page length	0.39" to 12.00"	
8.Page thickness	0.005" to 0.010"	
9.Internal paper roll		
(1)Winding direction	Printing surface outside/inside	
(2)Paper roll outer diameter	5.9" (150mm) or less	
(3)Paper tube inner diameter	$3_{-0.04}^{+0.08}$ inch ( $76.2_{-1}^{+2}$ mm)	
10.Form sensor type	(1)Interruptive-type form edge sensor (movable)	Detects notches and the backing paper
	(2)Reflective sensor movable	Detects "eye" marks
	(3)Interruptive-type center sensor (fixed)	Detects backing paper and center hole.
11.Ribbon width	1.57" to 4.72" (40 to 120mm)	At least 0.39" (10mm) wider than the forms (less than 0.78" (20mm))
12.Supply ribbon roll	(1)Winding direction : Ink on the outside	
	(2)Paper tube inner dimension : $1_{-0}^{+0.04}$ inch	( $25.4_{-0}^{+1}$ mm)
	(3)Length of ending silver tape : 5.90" or more	
	(4)Winding dimension : 2.76" or less	
	(5)Ribbon length : 985ft (reference value)	
13.Host interface	SCSI conforming	
14.External dimensions	Height	12.6" (330mm)
	Width	11.4" (290mm)
	Depth	11.8" (300mm)
15.Weight	41.8lbs (19Kg) or less	
16.Power consumption	150W	
17.Input power	230V AC 50HZ	
18.Operating temperature and humidity requirements	5 - 35 、 10 - 85%RH (non-condensing)	See Temperature-Humidity Graph
19.Options		
-1.External roll holder	Field option	Roll diameter : 9.84" (250mm) or more
-2.Pealer	Field option	
-3.Cutter	Field option	

## APPENDIX B Interface

---

The SCSI communications ports are located on the right rear side of the printer.

The signal assignments for the two SCSI connectors are shown below.

No.	Signal name	No.	Signal name	No.	Signal name	No.	Signal name
1	GND	26	DB0	14	GND	39	GND
2	GND	27	DB1	15	GND	40	GND
3	GND	28	DB2	16	GND	41	ATN
4	GND	29	DB3	17	GND	42	GND
5	GND	30	DB4	18	GND	43	BSY
6	GND	31	DB5	19	GND	44	ACK
7	GND	32	DB6	20	GND	45	RST
8	GND	33	DB7	21	GND	46	MSG
9	GND	34	DBp	22	GND	47	SEL
10	GND	35	GND	23	GND	48	C/D
11	GND	36	GND	24	GND	49	REQ
12	GND	37	GND	25	GND	50	I/O
13	GND	38	TERMPWR				

The connector for SW (400dpi) is the bellows type of half-pitch size with 50 pins (female).

The connector for SW-600 (600dpi) is the pin type of half-pitch size with 50 pins (female).

### Electrical requirements

The transmission system is considered to be a single-end system, and the electrical requirements concerning the SCSI bus I/O characteristics and timing characteristics conform with SCSI (Small Computer System Interface - ANSI X3.131-1986 and JIS X 6051-1990/ISO 9316-1989).

However, the operating characteristics are stipulated only for the case where the printer is a target. The printer supplies terminator power.

## APPENDIX C Specifications for Labels and Ribbons

---

### RECOMMENDED LABELS AND RIBBONS

Use the specified labels and ribbons (ink ribbons) on this printer.

No.	Label	Ribbon
1	DURATAACK 10PN	DURAINK 10PN
2	DURATAACK PON	DURAINK 10PN
3	DURATAACK PT	DURAINK DLH
4	NP coated paper	DURAINK G

**Note**

**Be sure to use the recommended labels and ribbons.**

**Using non-recommended labels or ribbons can result in problems such as poor print quality and damage to thermal head or other printer components.**

**Use non-recommended labels or ribbons on your own authority.**

# APPENDIX D Label Specifications

## 1 . Layout of page detection areas

(1) Backing paper (Interruptive-type center sensor)

There must be a backing paper position of 0.04”(2mm) to 0.20”(5mm) in direction of height. The width of the center part of the label must be 0.20”(5mm) or more.

The sensor output potential difference between label and backing paper must be 1V or more.

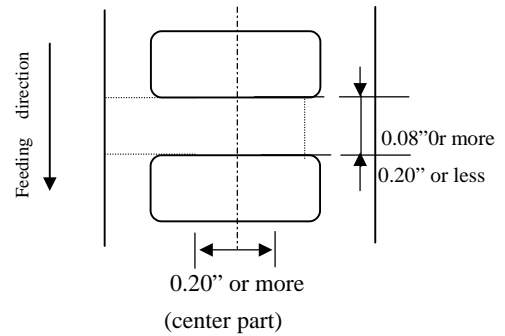

(2) Backing Paper (Interruptive-type form edge sensor)

The trimming in the left edge of the forms (looking from the front of the printer), must not be wider than 0.35” (9mm). The backing paper part between labels must be not less than 0.08” (2mm) and not more than 0.20” (5mm). The printing surface must be 0.24” (6mm) or wider.

The sensor output potential difference between label and backing paper must be 1V or more.

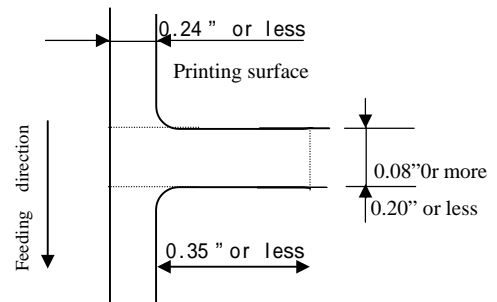

(3) Notches (interruptive-type form edge sensor)

In the left edge of the forms (looking from the front of the printer), there must be notches that satisfy the dimensions indicated below:

When page length is less than 2.75” (70mm):  
 $0.35”(9mm)W$  or more  $\times 0.08”(2mm)H$  to  $0.16”(4mm)H$

When page length is 2.75” (70mm) or more:  
 $0.35”(9mm)W \times 0.08”(2mm)H$   
 to  $0.47”(12mm)W \times 0.20”(5mm)H$

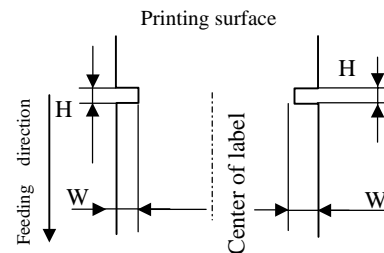

(4) Back-side “Eye” marks (Reflective sensor)

Dimensions: 5mm or less

There must be an “eye” mark of

$0.47”(12mm):W \times 0.12”(3mm)$  to  $0.20”(5mm):H$  within the region indicated by dotted lines in the figure at right.

The sensor output potential difference between “eye” mark and other portions of the label must be 1V or more.

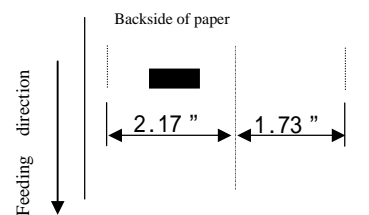

(5) Center hole (Interruptive-type center sensor)

Inner diameter:  $0.12”(3mm)$  to  $0.20”(5mm)$

The center of the hole must be within  $0.02”(0.5mm)$  of the center of the form width

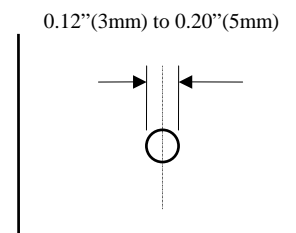

## 2. Miscellaneous (Printing Area)

Printing must occur within the shaded regions in the illustrations

(1) Diecut forms

Page length up to 3.94"(100mm):

0.06"(1.5mm) or more (in direction of height)

Page length over 3.94"(100mm):

0.10"(2.5mm) or more (in direction of height)

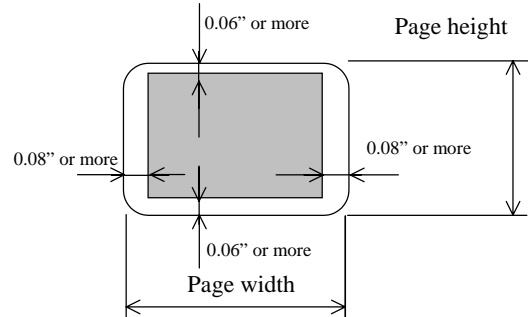

(2) Other than diecut forms

Page length up to 3.94"(100mm):

0.06"(1.5mm) or more (in direction of height)

Page length over 3.94"(100mm):

0.10"(2.5mm) or more (in direction of height)

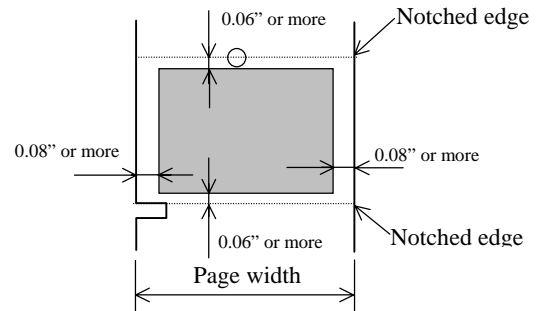

Note:

**The dropped or blurred printing may occur outside the printing area.**

**Do not allow barcodes and characters to go over the edge of the label.**



## APPENDIX E The Position of the Thermal Head

---

1. When the thermal head has been moved after replacing the ink-ribbon or cleaning or replacing the thermal head, etc., make sure that the thermal head is returned to its correct position.
2. See the illustration below. Move the thermal head forward, so that the positioning plates touch the screws. This is the correct position of the thermal head. The positioning plates and the screws are located on both sides of the thermal head. Make sure that the positioning plate on either side touches the screw.
3. When the thermal head slips back, wrinkling of the ink-ribbon or blurred printing may occur.

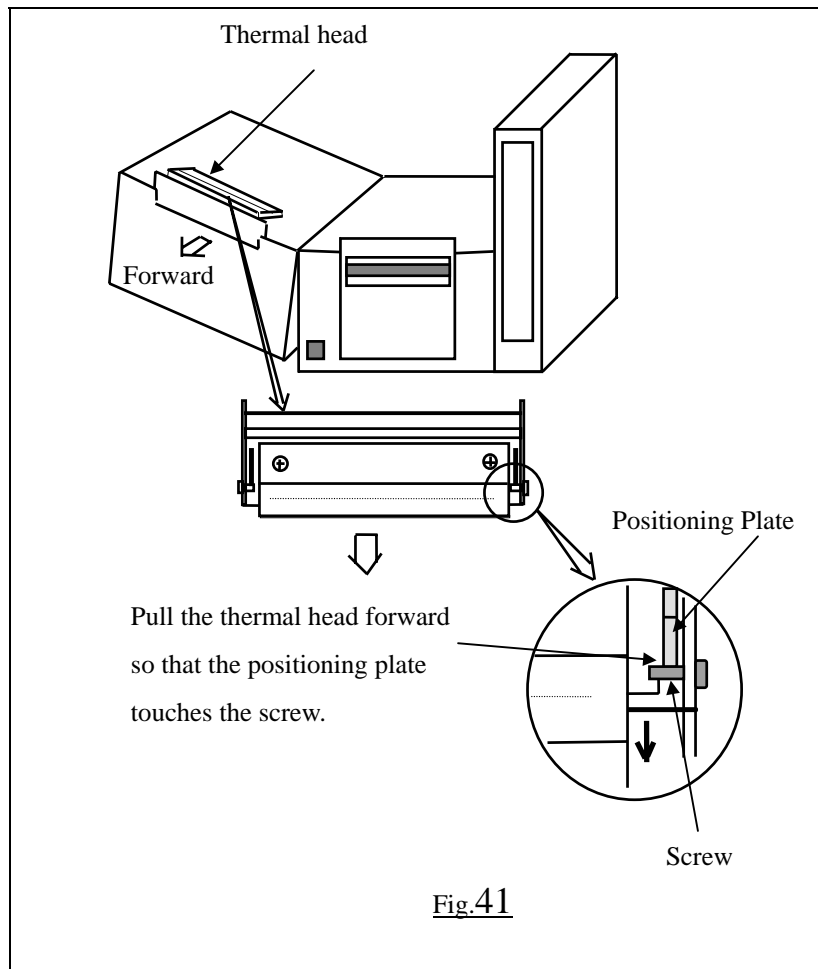

# APPENDIX F Important Items of Daily Operation

---

## 1. Setting the Labels and Ink Ribbon

### (1) Setting the labels

Set the labels straight without lateral deviation, using the edge of center fixing type sensor as a basis.

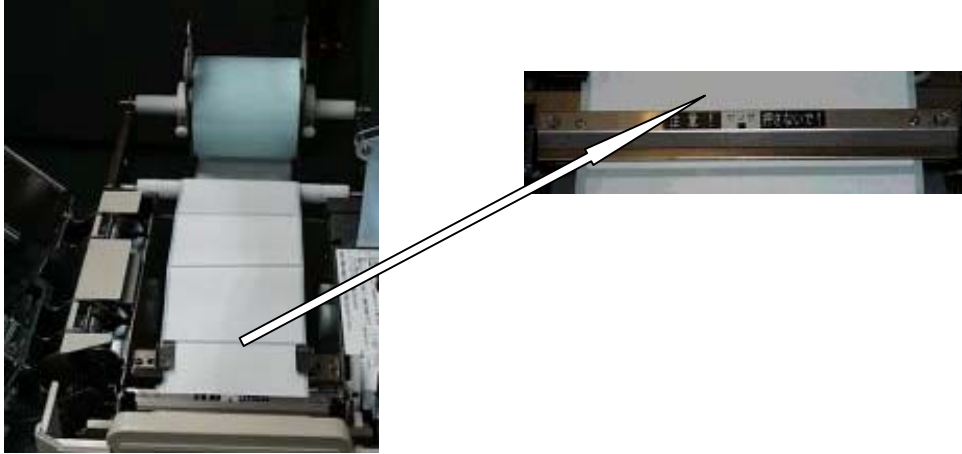

Pay attention to the paper feed pass when the external roll holder is used.

Label inside wind: From upper side (Label outside wind: From lower side)



### (2) Setting the ink (ribbon)

Set the ink ribbon straight without lateral deviation (torsion) of ribbon being fed or taken up.

Good



Bad





## 2. Cares When Operating

### (1) When supplies are replaced, the following requirements must be met.

- [1] Do not turn off the power to the personal computer.

Otherwise the data sent from the personal computer are lost.

If the power was turned off on SW printer, once quit operation of personal computer, and start it again after printer power ON.

(Select “Restart Computer” on the termination screen of Windows, and execute it.)

- [2] When replacing supplies, do not wear metallic protruding articles, such as watch.

Otherwise the heating element of thermal head is damaged, resulting in wire breakage.

- [3] Be sure to set the moving sensor (when it is used).

If the moving sensor was once shifted to a side for easier label setting, be sure to return it to its original position.

### (2) When error such as supply error, label jam and so on occur on SW printer, do not turn off the power at once. Because the indication of error appears on the screen.

### (3) Do not touch the following parts with bare hand.

- [1] Label surface (print surface)

- [2] Ink transferring surface

- [3] Heating element of thermal head

### (4) Do not press the center fixing type sensor with undue force.

- \* Label jam is caused.

- \* Do not remove the center fixing type sensor even when it is not used.

It serves to suppress label lift.

### (5) During printing do not pull the label with undue force.

- \* Otherwise print deviation occurs.

### (6) Do not tighten excessively the fixing screw for the backing of externally provided roll holder when the external roll holder is used.

- \* Otherwise normal rotation is disturbed.

## 3. Daily Check

The following daily check is required. After checking clean the machine as necessary according to the specified procedure.

### (1) Checking before starting work at the beginning of week

- [1] State of surface of thermal head: Flaw, sticking dust, extent of wear

- [2] State of platen roller surface: Flaw, sticking dust

- [3] Inside of printer: Existence/nonexistence of dust

- [4] Externally provided holder: Sticking dust, checking of installation position

### (2) Daily check

- [1] Inside of printer: Existence/nonexistence of dust

- [2] Thermal head: Existence/nonexistence of dust

### 3-1. Cleaning

This is important item in order to keep the printer in peak condition for a long time, be sure to perform the maintenance described below.

Clean the following parts according to the check cycle.

(1) Thermal head unit

- \* Clean the parts in addition to the heating element.
- \* Be sure to turn off the power before cleaning.
- \* Cleaning should be performed before start of work.



Wipe the heat element component of the thermal head several times only in one direction



Put the winding ink ribbon on the V notch of Upper cover to see the thermal head surface correctly.

<Cleaning Cloth>

The cleaning cloth intended for the thermal head is packed with the printer or the thermal head at the time of purchase. The cleaning cloth is dampened with IPA and you can polish the thermal head most effectively with it.

**Replace the thermal head if you cannot improve the print quality.**

## DURAPRINER SW

---

### (2) Platen roller unit

If contamination by paper dust is significant, take out the unit, and clean it.



Taking-out method: Releasing the left and right locks, remove upward.

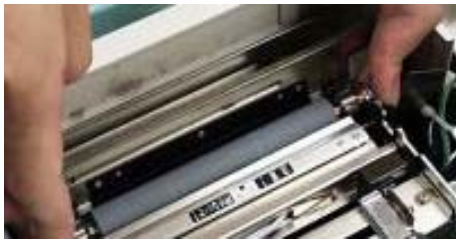

Left lock



Right lock

### (3) Paper sensor unit and Label output area

