



THERMAL BARCODE PRINTER

Operator's Manual Rev.C

[220-240V AC]

NITTO DENKO

Important Safeguard

Important Safety Instructions

Symbols

Various symbols are used in manuals (including this manual) and on the printer body to help you use this product properly and to prevent harm to you and other people and the damages to the property. The symbols and their meanings are shown below.



Warning

• • • This mark indicates that a death or a serious injury may occur if you handle this printer improperly ignoring the warning.



Caution

• • • This mark indicates that a slight injury or damage to property may occur if you handle this printer improperly, ignoring the caution.

Examples



△ shows that you must pay enough attention to something.
Sometimes this mark indicates a hazard or a warning.



The mark ⊘ shows that something is prohibited.
In ⊘, what is prohibited is shown specifically.
For example, the mark at the left shows that disassembly is prohibited.



• Shows that you are required to do something.
• In the required act is shown specifically.
For example, the mark at the left shows that connection to a ground is required.

For the safe use of this printer, the following safety precautions should always be followed.

Warnings



- Be sure to connect the ground. A leakage of current without the grounding may cause an electric shock or a fire. If there is no grounding terminal, ask an electrician to set up one. Do not use this printer without grounding.



- Be sure to use this printer at the rated power supply voltage. Do not use a multi-outlet adapter to avoid an electric shock and a fire.
- Do not use an extension cord.
- Do not break damage or adapt the power cord. It is also prohibited to put heavy materials on the cord and to yank or bend the cord excessively. A damaged power cord may cause an electric shock or a fire.



- Set up the printer as close as possible to the receptacle so that you can easily unplug the power cord under abnormal conditions.



- Do not disassemble or adapt the printer to avoid an electric shock or a fire.
- Follow the instructions on the manuals in maintenance and inspection. Improper handling may cause an electric shock or a fire.



- When abnormal conditions such as smoke or abnormal odors coming from the machine are encountered, turn the power off at once, unplug the power cord and then make contact with your service representative. It may cause a fire or an electric shock to keep using the printer under abnormal conditions.
- When some foreign material such as a piece of metal, water and other liquid goes into the printer, turn the power off at once, unplug the power cord and then make contact with your service representative. It may cause an electric shock or a fire to keep using the printer under abnormal conditions.



- Do not put a vase, a flower pot, a cup, or a case containing liquid on the printer. The spilled water may cause an electric shock or a fire.



- Do not plug or unplug the power cord with moistened hands to avoid an electric shock.

For the safe use of this printer, the following safety precautions should always be followed.

Cautions



- Do not place the printer where it will be exposed to dust, dirt and dampness to avoid a fire or an electric shock.
- Avoid putting the printer on an unstable place such as an unsteady or an inclined rack and so on. The printer may fall down or drop down on someone and may cause an injury.



- Unplug the power cord before you move the printer. A damaged power cord may cause a fire or an electric shock.
- If you do not use the printer for a long time, remove the line cord plug from the receptacle for the safety reason.



- Whenever plugging or unplugging the power cord, always grasp the plug, not the cord to avoid any damage to the cord.
A damaged power cord may cause a fire or an electric shock



- Take care not to burn your hands by touching the hot part inside the printer in clearing a paper jam, replacing the paper, or cleaning.

DURAPRINTER SR

PREFACE

Thank you very much for your utilizing DURA PRINTER SR by NITTO DENKO.

DURA PRINTER SR is a thermal transfer label printer used with the specific labels/tags and ribbons.

This manual explains how to operate and control the DURA PRINTER SR so that you can use and maintain the printer in an optimal fashion. Before attempting to use the printer, be sure to read this manual all of the way through.

Keep this manual and the Unpacking Instructions that are packaged with the printer in a safe place for future reference.

Note that due to our continuing efforts to improve and refine our products, the descriptions and illustrations provided in this manual may differ slightly from your printer.

DURAPRINTER SR

HANDLING OF DURATAACK AND DURAINK

Thank you very much for utilizing DURA PRINTER SR by NITTO DENKO.

DURAPRINTER is the thermal transfer label printer used with specific labels/tags and ribbons.

The specific labels and ink ribbons are DURATAACK series and DURAINK series.

Use non-recommended labels or ink ribbons at your own risk.

This document explains how to handle and operate the DURATAACK and DURAINK.

Before attempting to use the labels and ink ribbons, be sure to read this manual all of the way through.

Incorrect handling or use may cause print quality degradation.

HANDLING OF DURATAACK SERIES

1. Storage conditions

- (1) Store the product in a well ventilated area at room temperature where it will not be exposed to direct sunlight.
- (2) The warranty period is 6 months after delivered. After expiration of the warranty period verify the product quality before use.
- (3) Do not store in a vertical state. Store it in a horizontal state.
- (4) Store product as individually packaged from manufacturer so as to prevent contamination.
- (5) The product is wound loosely so as to prevent winding deformation. Do not rewind tightly when storing.

2. Handling

- (1) DURATAACK has the approved size with tolerance. It is required to adjust the deviation within tolerance range by the following method (printer or application software).
 - Longitudinal direction (label size, pitch size): Adjustment of print position (up-down)
 - Lateral direction (Label size, liner left/right space): Adjustment of print position (left-right), setting of roll holder and guide.
- (2) Install according to operation manual for the printer that you use.
 - example: Position label centered on spindle to prevent ink ribbon wrinkle.
- (3) Insure there is suitable combination of ink ribbon and label depending on size, material and print energy.
 - Unsuitable combination may cause print failure or malfunction.
- (4) Do not touch the label surface (transfer surface) with your bare hand.
 - Oil is applied and impedes ink transfer, causing print failure.
- (5) Some label rolls may have splicing areas on the liner. If the printer stops at the splicing area, restore the normal state by using the SET TOF function (the operation differs depending on the printer).
- (6) DURATAACK series labels are not designed for printing process occurring in the following conditions:
 - outdoors, dusty environments or solvent/chemical splash locations. Print image quality is not guaranteed.
 - Dust causes print troubles.
- (7) In principle provide the left/right and top/bottom space (about 1 mm each) in view of treatment tolerance, label setting accuracy, printer label transfer accuracy, etc. If the format deviates outward from the label, the dirty and breakage of thermal head, reduction of consumable parts life, or damage of ink ribbon may be caused.
- (8) There is incomplete print or some labels that are impossible to print on at the end of roll owing to specific printer construction. In this case take the following measures:
 - Incomplete print: Re-print on the first label after replacement of label roll (in case of re-print mode setting).
 - Impossible to print: There are some surplus provision labels in a roll.
- (9) When any option equipment such as printer synchronizing label peeling unit (peeler), label peeling machine, auto cutter unit, etc., special treatment may be required.

HANDLING OF DURAINK SERIES

1. Storage conditions

- (1) Store the product in well ventilated area at room temperature where it will not be exposed to direct sunlight.
- (2) The warranty period is 6 months after delivered.
After expiration of the warranty period verify the product quality before use.
- (3) Store product as individually packaged from manufacturer so as to prevent contamination.

2. Handling

- (1) Install according to operation manual for the printer that you use.
example: Position ribbon centered on spindle to prevent ink ribbon wrinkle.
- (2) Insure there is suitable combination of ink ribbon and label depending on size, material and print energy.
Unsuitable combination may cause print failure or malfunction. Especially, if the size of ink ribbon is equal to or smaller than the size of label liner resulting in ink ribbon wrinkles, print failure and reduction of consumable parts life or thermal head life. Also, thermal head breakage may be caused due to dirty of thermal head.
- (3) The DURAPRINTER series is designed so that the direct thermal paper can also be used.
Existence/nonexistence of ink ribbon is not detected while printing direct thermal paper, and installation of ink ribbon does not cause error condition.
The sensor detects only the silver tape at the ink ribbon end, indicating empty error.
- (4) As to the ink ribbon winding core, use the core that comes with the printer when it is newly purchased.
After that, use the used unwinding core as a winding core (rotation).
Be sure to discard the rewound ink ribbon and do not wind a new ink ribbon on it.
- (5) DURAINK series ribbons are not designed for reuse. Print failure will occur.
- (6) Do not touch the ink ribbon surface (transfer surface) with bare hands.
Oil is applied and impedes ink transfer, causing print failure.
- (7) DURAINK series ribbons are not designed for printing process occurring in the following conditions:
outdoors, dusty environments or solvent/chemical splash locations. Print image quality is not guaranteed.
Dust causes print troubles.

DURAPRINTER SR

Contents

1.ORGANIZATION OF THIS MANUAL	1
2.UNPACKING	2
2-1.CHECKING THE PACKING LIST	2
2-2.REMOVING THE PROTECTIVE DEVICES ON THE PRINTER	3
3.INSTALLATION ENVIRONMENT AND POWER SUPPLY CONNECTIONS	4
3-1.INSTALLATION ENVIRONMENT	4
3-2.GROUND AND POWER SUPPLY CONNECTIONS	5
4.NOTES ON USE	6
4-1.NOTES ON HANDLING	6
4-2.NOTE ON USING LABELS/TAGS	6
4-3.CONSUMABLES	7
4-4.LABEL RE-PRINT	8
5.DESCRPTIONS OF PARTS	9
5-1.NAMES OF PARTS	9
5-2.NAMES OF Vfr (VERIFIER UNIT) PARTS	10
5-3.FRONT CONTROL PANEL	11
5-3-1.FUNCTIONS IN THE NORMAL LABEL ISSUING MODE	11
5-3-2.SWITCHING TO THE FUNCTION SETTING MODE AND UTILIZING ITS FUNCTIONS	12
5-3-2-1.FUNCTION NUMBERS AND SETTING VALUES	13
5-3-2-2.EXAMPLE OF THE FUNCTION SETTING PROCEDURE	16
5-3-3.HOW TO SELECT FUNCTIONS	18
5-3-4.TO EXIT THE FUNCTION SETTING MODE	18
5-3-5.PRINTING OUT THE FUNCTION NUMBER SETTING	18
6.FUNCTIONS OF INDIVIDUAL PARTS	19
6-1.PRINTER INITIALIZATION OPERATION	19
6-2.MANUAL LENGTH MEASUREMENT	19
6-3.BACK PANEL DIP SWITCH SETTINGS (FOR THE RS232CINTERFACE)	21
6-4.PAPER DETECTION SENSORS	21
6-5.PAPER SENSOR VOLTAGE SELECTOR SWITCH	22
7.LOADING LABELS/TAGS	23
8.LOADING RIBBON	25
8-1.LOADING RIBBON	25
8-2.REPLACING RIBBON	28
9.CHANGING THE THERMAL HEAD PRESSURE	29
10.TEST PRINTING	30
11.MAINTENANCE	31
11-1.CLEANING THE INSIDE OF THE PRINTER	31
11-2.REMOVING THE INTERRUPTIVE-TYPE CENTER HOLE SENSOR	35
12.REPLACING COMPONENTS	36
12-1.REPLACING THE THERMAL HEAD	36
12-2.REPLACING THE PLATEN ROLLER	39
12-3.REPLACING THE FUSE	40
13.TROUBLESHOOTING	41
APPENDIX A BASIC SPECIFICATIONS	45
APPENDIX B SERIAL INTERFACE	48
APPENDIX C RECOMMENDED LABELS AND RIBBBONS	50
APPENDIX D MEMORY CARD	51
APPENDIX E LABEL SPECIFICATIONS	52

DURAPRINTER SR

APPENDIX F	THE POSITION OF THE THERMAL HEAD	55
APPENDIX G	FUNCTION SETTING LIST	56
APPENDIX H	THE FRONT LABEL POSITIONING METHOD (SET TOF)	58
APPENDIX I	IMPORTANT ITEMS OF DAILY OPERATION	59

1. Organization of This Manual

- Read this manual from the beginning. Read the cautions and important notes in particular very carefully before using the printer.
- Unpacking (Chapter 2)
This chapter instructions for unpacking, and describes the items included with the printer.
- Installation (Chapter 3)
This chapter explains points that require special attention when setting up the printer.
- Cautions Concerning Use (Chapter 4)
This chapter provides cautions concerning the handling of the printer and the use of labels/tags.
- Description of Parts (Chapter 5)
This chapter explains the names of the parts of the printer and how to operate the front control panel.
- Functions (Chapter 6)
This chapter explains the initial settings of the printer, and tasks that must be performed each time the labels/tags are replaced.
- Loading Labels/Tags and Ribbon (Chapters 7 and 8)
These chapters explain how to load labels/tags and ribbon. (Use the specified labels/tabs and ribbon.)
- Test Printing (Chapter 10)
This chapter explains the test printing procedure. Test printing is used to determine whether a problem lies with hardware or software. It is also used to check printing quality.
- Maintenance (Chapter 11)
This chapter explains how to clean each section of the printer. Periodic and proper cleaning of the printer will enable you to use it in optimal condition for a long time.
- Component Replacement (Chapter 12)
This chapter explains how to replace the thermal head, platen roller, and fuse.
- Troubleshooting (Chapter 13)
This chapter explains how to resolve problems.

Note:

Understanding references to the "left" and "right" side of the printer

References in this manual to the "left" and "right" side of the printer refer to the left and right sides of the printer when viewed from the front of the printer (where the form ejection opening is).

2. Unpacking

Detailed illustrations are provided in the "Unpacking Instructions" included in the carton.

Open the outer carton, and remove the accessories and padding material.

Lift the printer up and out of the outer carton.

Carry the printer carefully in both hands with it leaning against your body, and gently place it on a desk or table.

Remove the vinyl bag and the packet of silica gel.

Outer Carton

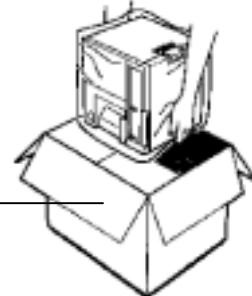

Fig.1

⚠ Cautions:

- When setting the printer down, be sure to avoid pinching your fingers between the printer and the table or desk.
- The printer weighs approximately 41.8lbs(19kg). When lifting the printer out of the outer carton, hold the printer on the bottom and be careful not to drop it.
- The unpacking instructions, the outer carton, and the padding material will be needed if it is ever necessary to repack the printer. Therefore, be careful not to damage them while unpacking the printer, and store them carefully for future use.

2-1. Checking the Packing List

After removing the printer from the carton, make sure that you have all of the items listed below and that they are not damaged. (Detailed illustrations are provided in the "Unpacking Instructions" that are included in the carton.)

- Main Printer Body
- Two ribbon roller gear units
- One ribbon core
- Two roll pressure plates
- One roll holder shaft
- One power cord
- One spare fuse
- One screwdriver
- One output slot paper guide
- One Operation Manual (this manual)
- Unpacking Instructions
- One guarantee card
- Cleaning cloth



Fig.2

2-2. Removing the Protective Devices on the Printer

Unscrew the metal anchor fittings on top of the printer and remove them.
Then, insert the screws back into the printer.

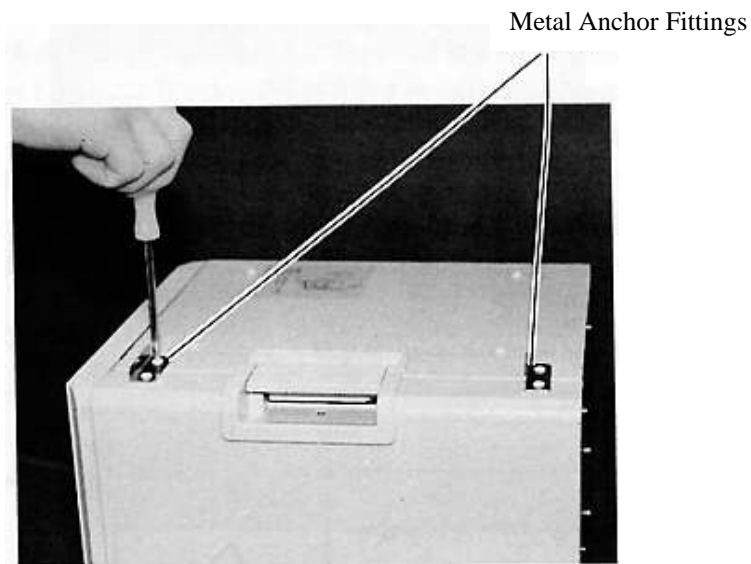

Fig.3

Remove the thermal head protective sheet and the verifier protective pad.

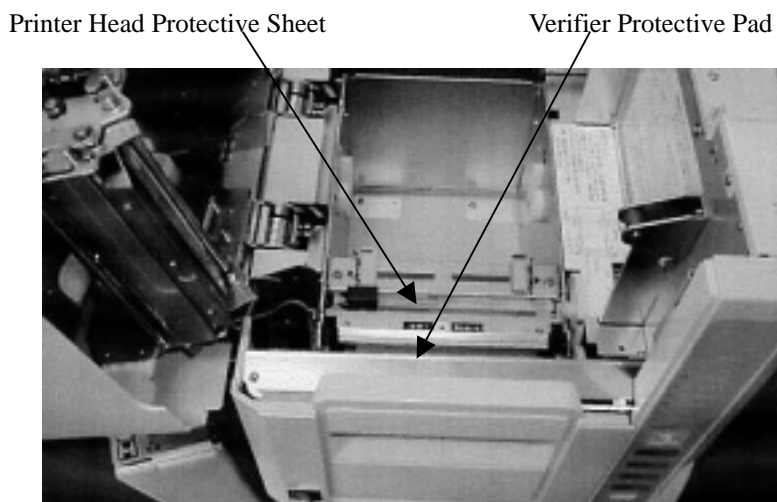

Fig.4

Note:

Store the locking brackets and the thermal head protective sheet, since they will be necessary if you ever need to repack the printer.

3. Installation Environment and Power Supply Connections

3-1. Installation Environment

- Select a stable location where the printer can be installed with plenty of room.
In order to get the maximum performance from the printer and in order to ensure safe usage, keep the following points in mind.
- In order to make it easier to operate and inspect the printer, allow for plenty of space around the printer. A space of 6"(150mm) or more on the left side of the printer in particular should be kept free of obstacles.
- The printer should be used in a dust- and dirt-free environment.
- Make sure that the power supply that is input to the printer is not subjected to large, temporary fluctuations in voltage or current, and that the printer is not subjected to broad-band noise or electrostatic discharge.
- Install the printer in a location that is not exposed to direct sunlight and is not subjected to rapid changes in temperature and humidity.
- When connecting the power cord, be sure to connect the ground.
- Do not install the printer in a location that is subject to vibration.
- Install the printer as far away as possible from radios and television sets.

Caution

When installing the printer, make sure that at least 6"(150mm) or more area on the left side of the printer is free of obstructions, as shown in the diagram at right. If this clearance is not provided, there is a danger that the printer could fall from the desk or table when the cover is opened.

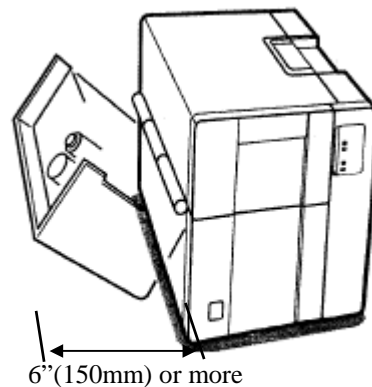

Important

When installing or moving the printer, tilt it toward you, then lift after sliding your fingers into the space between the printer and the desk. Be careful not to pinch your fingers.

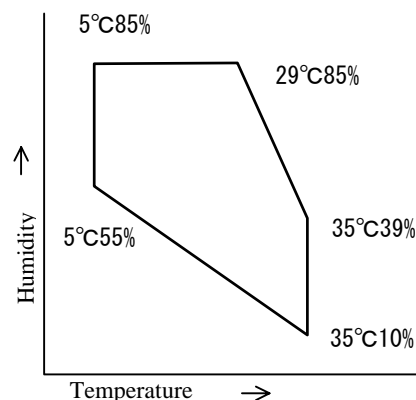

Reference

The dimensions and weight of the printer are as follows:

Temperature-Humidity graph

Width : 11.4 inches (290mm), Depth : 11.8 inches (300mm)

Height : 12.99 inches (330mm), Weight : 41.8lbs (19kg)

See the Temperature-Humidity graph for the operating temperature and operating humidity (non-condensing).

3-2. Ground and Power Supply Connections

Please observe the following precautions for safe operation.

- In order to avoid damage from electrostatic discharge, lightning strikes, leak current, etc., be sure to connect the ground before connecting the power supply.
 - ★ Do not use a gas pipe as a ground, which could result in a fire, gas explosion, or damage to the equipment.

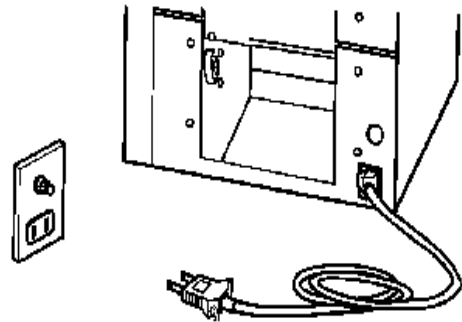

- The AC mains should be capable of providing at least 15A.
(Providing AC power 207~253V)

- The outlet that is used for the printer should be used only for the printer.
 - ★ Using a multi-outlet adapter or extension cord can result in a fire or in miss-operation.

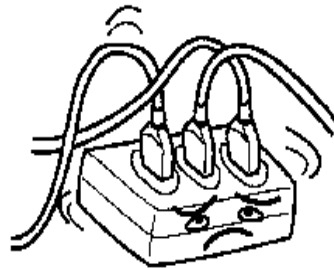

- Stepping on or pressing on the power cord can result in an accident, such as a fire or electric shock. Be careful not to crush the cord, especially when moving desks, etc.



- Make sure that the power cord is plugged in as far as it will go. Do not use a loose outlet, which can result in a poor connection. Such an outlet could cause a fire. If you will not be using the printer for an extended period of time, unplug the power cord from the outlet.

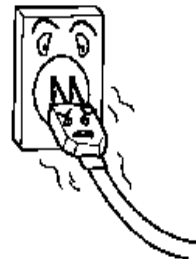

4. Notes on Use

4-1. Notes on Handling

Do not move or carry the printer while it is printing.

This printer does not have a waterproof construction. Do not spill water or other liquids on it.

Use a shielded cable for the interface cable. If an unshielded cable is used, it is possible that noise will be generated on nearby television sets and radios.

Whenever plugging in any connectors, be sure to turn the power off first.

Whenever plugging in or unplugging the power cord, always grasp the plug, not the cord.

Do not modify the printer or remove any components.

- Do not put something before the exhaust hole. Ensure that the exhaust hole remains unobstructed.

If the exhaust hose is obstructed, the inside temperature of the printer rises too high, which can result in the damage to the printer.

If you suspect a malfunction or other abnormality (such as abnormal odors, heat, or sounds), turn off the power immediately, unplug the power cord, and contact your service representative. Do not continue to use the printer if it has malfunctioned or if any other abnormality has occurred.

Cleaning the Output Slot Paper Guide

Pull out the output slot paper guide and remove the dirt and dust.

4-2. Notes on Using Labels/Tags

Labels/Tags and Ink Ribbons

Be sure to use the recommended labels and ribbons.

Using non-recommended labels or ribbons can result in problems such as poor print quality and damage to thermal head or other printer components.

Use non-recommended labels or ribbons on your own authority.

Use such an ink ribbon that is 0.39" (10mm) or more wider than the backing paper (though narrower than 0.79" (20mm)). If the backing paper of the labels touches the thermal head directly, the thermal head may be worn which can result in the breakdown of the head.

- Pre-printed Label

The pre-printed labels that has already frames or lines printed on them may damage the thermal head because of the ink used in pre-printing. When you are going to use pre-printed labels, contact us or your dealer and check whether the labels are suitable. The ink that contains pigment particularly shortens the useful life of the thermal head remarkably. Be sure not to print on the pre-printed portions because the ink will be attached to the heated thermal head which causes the poor print quality.

To use pre-printed label on this printer, select pre-printed label for the setting of function number 4 (paper type and sensor type).

- Label rolls and ribbon rolls

Store unused label rolls or ribbon rolls in a cool dark place, such as a desk drawer. When using a tag roll, use one that is wound with the tags on the inside.

● Recommended combination of supplies (size)

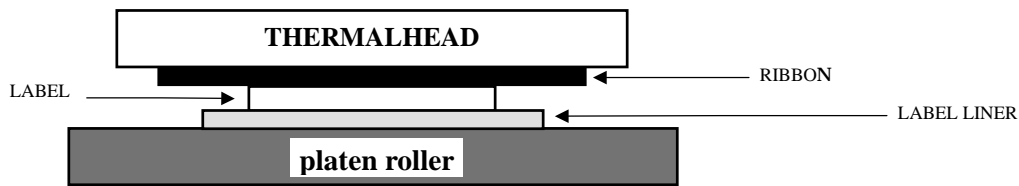

$$\begin{aligned} \text{Label liner width} + 20 \text{ mm} &> \text{Ink ribbon} && \text{Label liner width} + 10 \text{ mm} \\ \text{Label width} + 20 \text{ mm} &> \text{Label liner width} && \text{Label width} + 4 \text{ mm} \end{aligned}$$

The recommended combination of label, label liner and ink ribbon sizes is as shown above. Especially, the difference in width between label liner and ink ribbon gives the following effects (the ribbon is wider than the label liner).

The hardware design of the machine is based on this difference.

- (1) An allowance to transfer the platen roller carrying torque to the ink ribbon is required so as to ensure high running stability of ink ribbon which contacts tight the label and label liner which have different surface friction properties.
- (2) The thermal head must be protected (from wear) from staggering of label edge with respect to liner and from burrs of label liner edges.

4-3. Consumables

● Consumables

The thermal head and platen roller are consumable items. Holding them in reserve is recommended. Those items are user-replaceable.

4-4. Label Re-print

• Standard function of printer (Reprint Mode)

If an error (label running-out, Ink running-out, cover opened) occurs during operation, the printer stops at once.

Accordingly, this results in label print failure. The machine is provided with the standard function to print again the non completed print on the next label when the error is removed and the normal print is started again, so that number interruption and product omission are prevented.

This function is valid only for the errors for which the printer buffer is operative.

Accordingly, in the case when the print data remain in the printer, there is no need to send again print data from the personal computer when print is started again.

In most cases of errors the normal state can be restored without turning off the printer power.

• Apparently print-completed label

Occasionally the printer may judge that the print is not completed due to specific label pitch, format or error stop position during normal operation although the print has been apparently completed. In this case two same complete labels exist because the printer judges that the print is incomplete and performs re-printing, using its standard function.

• Countermeasures

There are two countermeasures against this trouble.

(1) When interruption of number occurs.

Add the "NORP" command as a print command.

In the case when the label format simple designing software DURARHYTHM is used, select [Tool] – [Option] – [Printer Option], and set [Reprint ater Error Stop] to [No].

(2) When interruption of number is not found

After disposition of error be sure to check visually the preceding and subsequent labels before starting the re-print.

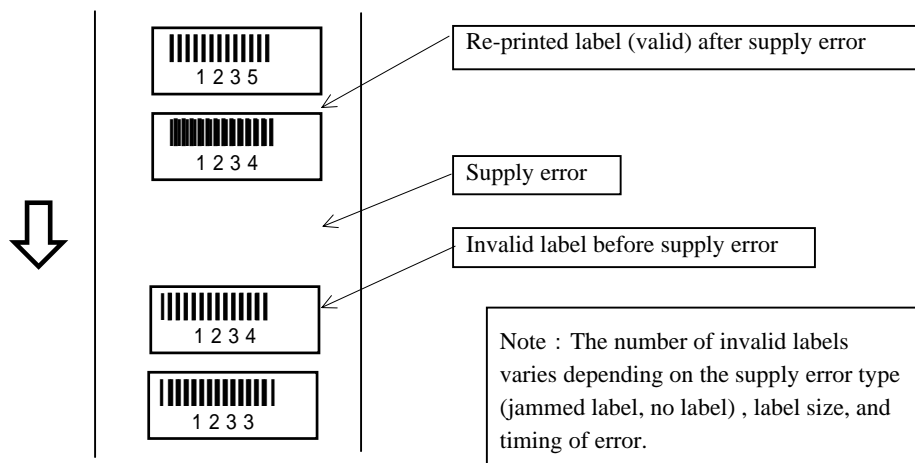

5. Descriptions of Parts

5-1. Names of Parts

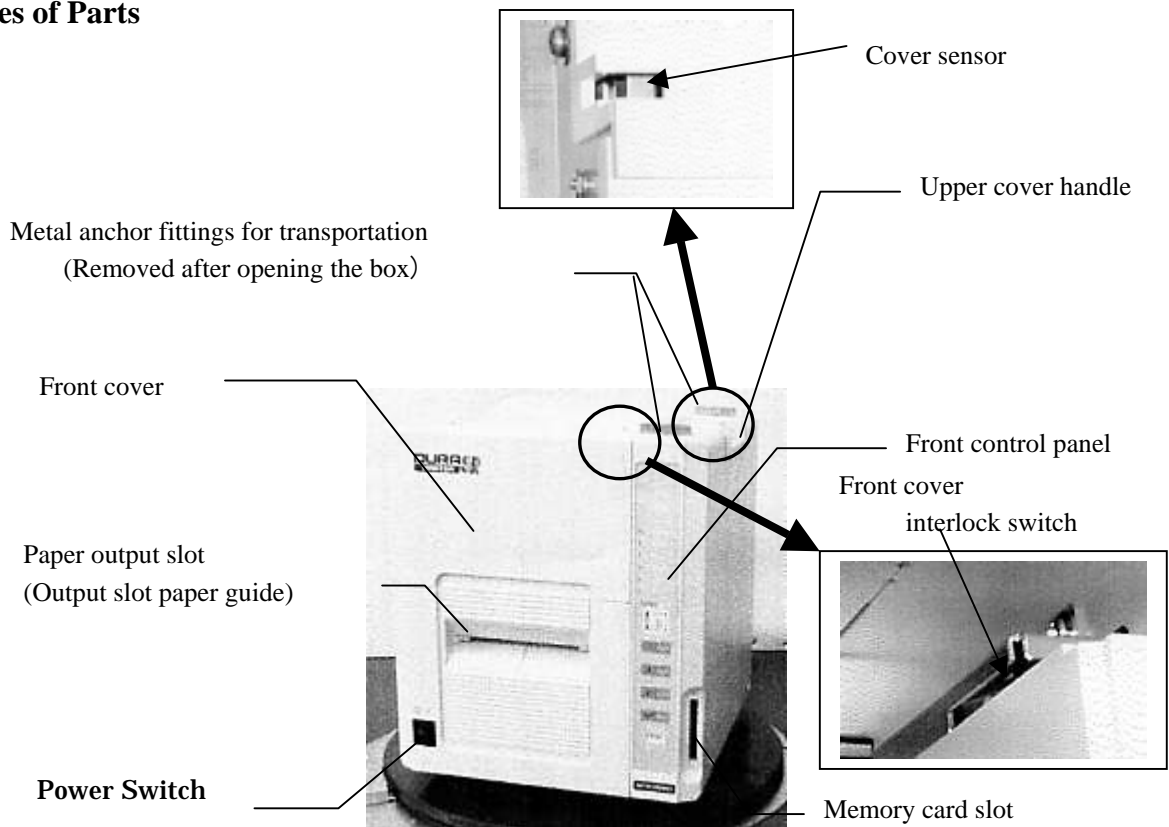

To install the paper output slot guide, insert it into the slots at the sides of the paper output slot.



Fig.5 Front View/Side View

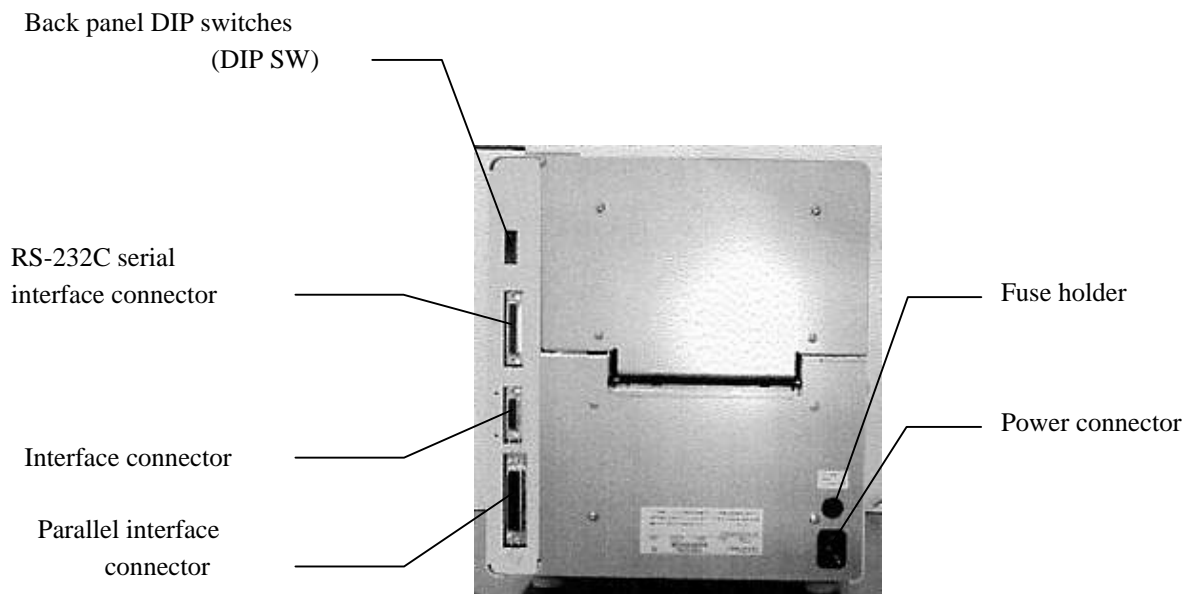

Fig.6 Rear View

5-2. Names of Vfr (Verifier Unit) Parts

Inside of the printer with Vfr (Verifier unit) seen from the rear position

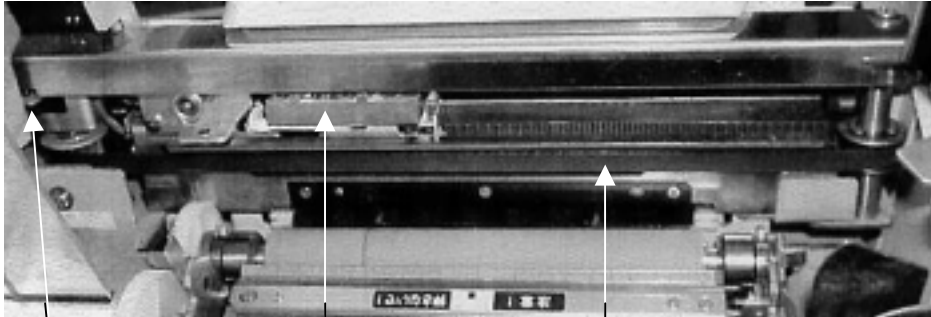

Fig.7

Home position sensor

Carriage

Carrier belt

Pen scanner

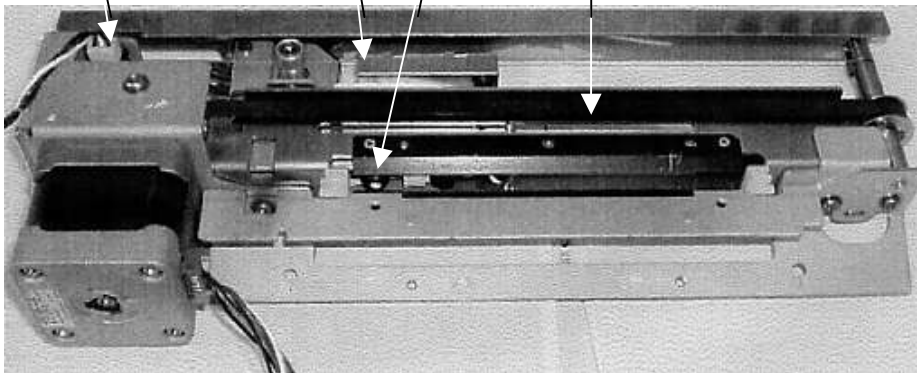

The printer without Vfr (Verifier unit)

Fig.8

Note

The pen scanner moves from side to side and the verifier unit verifies the barcode on the label. The verifier can not function correctly when the dust or a broken piece of the label is attached to the end of the pen scanner or inside the carrier belt. Clean the verifier unit regularly.

5-3.Front Control Panel

The control panel provides functions for producing labels (the label issuing mode functions) and for changing various printer settings to suit different applications (the function setting mode). Here the functions of both modes are described below.

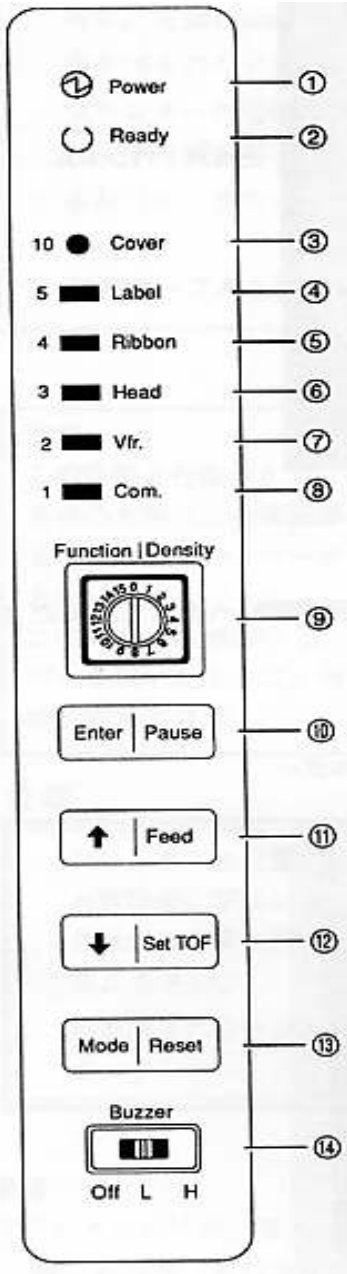

Fig.9 Front Control Panel

5-3-1 Functions in the Normal Label Issuing Mode

① **Power**

Indicates whether the printer's power is on or off.
The lamp turns on when the power is on.

② **Ready**

On: The printer is ready for printing (the ready state).
Off: The printer is in the paused print state (the pause state).

③ **Cover**

Lights when the cover is open.

④ **Label**

Lights when there are no labels left, and flashes if a label jam occurs.

⑤ **Ribbon**

Lights when the ribbon is exhausted.

⑥ **Head**

Lights when the thermal head is worn out or damaged.

When the cover sensor is closed while the verifier is inactive, "Head" LED is lit if the front cover interlock switch is OFF.

⑦ **Vfr.**

Lights in the event of multiple voids (when the barcode verifier continuously detects defective bar code).

When Label and Vfr lamps are ON at a time, Vfr hard error has occurred, or the front cover interlock switch is OFF while the cover sensor is closed.

⑧ **Com.**

Lights when a communication error occurs.

⑨ **Function/Density (Rotary SW)**

Print density can be controlled by the dial.

⑩ **Enter/Pause**

Switches the printer between the ready state and the pause state. Each time this switch is pressed, the Ready lamp turns on or off.

⑪ **↑ /Feed**

Pressing this switch ejects one page of labels.

⑫ **↓ /Set TOF**

Press this switch when you want to load labels manually.
Before pressing it, open the cover.

⑬ **Mode/Reset**

When an error occurs, pressing this switch cancels the error condition. (If the error condition does not clear, momentarily turn off the power.)

⑭ **Buzzer**

Controls the buzzer volume. (3 levels: Off/Low/High)

Note:
When more than one error lamp lights at the same time, some other cause may be responsible. For details, see "Error Display Lights" in Chapter 13, "Troubleshooting."

5-3-2. Switching to the Function Setting Mode and Utilizing its Functions

About the function setting mode

The printer is ordinarily used in the label issuing mode to issue labels. However, when using the printer for the first time, it is necessary to set the printer's functions to match the conditions of use. The state in which function settings can be made is referred to as the function setting mode. Once settings have been made in this mode, they are maintained even when the power is turned off. However, you may need to make some of these settings again after changing the ribbon or label stock.

① Entering the function setting mode

To enter the function setting mode, make sure that the Ready lamp is off and that no error LED is lit, then press and hold the [Mode|Reset] button for at least one second. The buzzer will beep repeatedly, indicating that the printer is in the function setting mode. (However, the buzzer does not beep if it is turned off.)

② The "Ready" LED flashes while the printer is in the function setting mode. In this mode, the rotary switch (which ordinarily functions as the print density selector) can be used to select the function number, and the LEDs from "Cover" LED to "Com." LED are used to display the setting for the selected function number. The following table lists the meanings of the function numbers and setting values.

Note:

- **Function settings can be made both using the front panel as described here, or by sending commands (function setting commands) from the connected host computer. For details on how to use function setting commands, see RCL Plus Command Reference Manual. Keep the setting as it may be necessary when the printer needs repair in the future. Note that if you make a particular setting more than once, only the last setting made is effective.**
- **If it is defined that the function setting is sent to the printer at the time of printing labels by DURA RHYTHM, the sent setting is effective.**

In order to change the function setting with the front control panel, select [No] for [Do you want to send this setting to the printer?] on Function Setting dialog box. Click [Tool] on the main bar on the Main Screen of DURA RHYTHM, select [Function Setting], and then the check box for [Do you want to send this setting to the printer?] appears.

5-3-2-1. Function Numbers and Setting Values

Note: The symbol * indicates that the new setting becomes effective only after the power is turned on again.

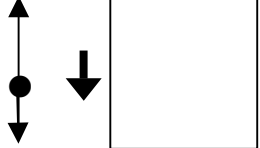
Function Number	Function	Setting Value	Setting	Remarks
0*	Length Measurement Method	1 2	Manual length measurement Length measured automatically at power-on	See 5.2 regarding manual Length measurement.
1*	Printer configuration	1 5 6 7 8 9	Standard 1 (On-demand : long) Manual peeling mode Mounter mode (Automatic model) Labeler mode (Automatic Model) Standard 2 (On-demand : short) Standard 2 (On-demand : half)	
2	Print starting position adjustment	1 2 3 4 5 6 7 8 9 10 11 12 13 14 15 16	0 +1(+0.005" (0.127mm)) +2(+0.010" (0.254mm)) +3(+0.015" (0.381mm)) +4(+0.020" (0.508mm)) +5(+0.025" (0.635mm)) +6(+0.030" (0.762mm)) +7(+0.035" (0.889mm)) 0 -1(-0.005" (0.127mm)) -2(-0.010" (0.254mm)) -3(-0.015" (0.381mm)) -4(-0.020" (0.508mm)) -5(-0.025" (0.635mm)) -6(-0.030" (0.762mm)) -7(-0.035" (0.889mm))	0.005"(0.127mm) increments (+)  (-) Slide the control toward + to move the print starting position toward the top of the label, and toward - to move it toward the bottom of the label <div style="border: 1px solid black; padding: 5px; width: fit-content; margin-top: 10px;">Note: The change becomes effective with the second label printed after sending data.</div>
3	Verifier active	1 2 3 4	Verifier active, Verifier & APPC ON Verifier active, Verifier & APPC OFF Verifier active, Verifier OFF, APPC ON Verifier Inactive	
4	Paper Type	1 2 3 4 5	White labels (Center hole sensor) Pre-printed labels (Center hole sensor) Continuous Forms White labels (Movable sensor) Pre-printed labels (Movable sensor)	When the pre-printed labels are used, follow the length measurement method for pre-printed labels.
5	On-demand quantity adjustment	1,9 2 — 16	0 +1 — -7	In 0.025" (0.635mm) steps On-demand quantity: Amount by which labels are advanced following printing.
6	Head Check	1 2	Use when voids occur repeatedly Regular use	
7	Jam detection	1 2	1.5 pages or more 3.5 pages or more	

DURAPRINTER SR

8*	Form length setting mode	1 2	Set by measurement Set by command	
9*	Print method selection	1 2 3	Format printing Text printing Hex dump printing	Format printing: Normal printing Text Printing: Printing by 10-key command Hex dump printing: Hex dump printing of commands
10	Supply type	1 2 — 16	Supply-1 Supply-2 — Supply-16	Supply1 (PN label/Paper label) Supply5 (PET label/PON label) Supply8 (S40H, C40H label /PON label) Supply9 (PET label/P label /PON label)
11	Label Transport speed	1 2 3 4	2.0ips/s 1.75ips/s 1.5ips/s 1.0ips/s	ips (inches/sec)
12	Returning from On-demand	1 2 3	Normal Printer feeds backward one extra page and does leading edge alignment Printer does leading edge alignment after returning from the on-demand position	• Use 2 or 3 when greater positioning accuracy is desired after starting printing. • With 3, one blank label page is output after returning from on-demand.
13	Printing Speed	1 2	High (Normal) Low (Fixed to the lowest speed of energy table)	Do not set a value other than 1 and 2.
14	Engineering mode	1	Normal	Bar width feed-back correction value This value is not user-changeable.
15	Engineering mode	1	Normal	Bar width feed-back correction value This value is not user-changeable.

Note:

- When printing text or using hex dump printing, switch to the continuous forms mode and use continuous direct thermal paper with a width of 3.94" to 4.33"(100 to 110 mm).

Note

- When verifier is active, keep the quiet zones (portions where nothing is printed) of not less than 0.12" (3mm) on both sides of the barcode.

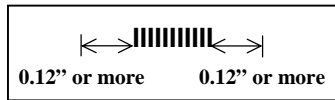

- To make the verifier inactive, change the setting of function number 3 to 4 (Verifier inactive).
When verifier hard error has occurred, turn on the power while pressing [Mode/Reset] to enter the function setting mode.

5-3-2-2. Example of the Function Setting Procedure

This section shows how to change the setting of function number 10(Supply type)to 9 when the current setting is 1 and the setting of function number 2 (Print starting position adjustment) is 6. The label issuing mode's rotary switch (print density) is assumed to be set to 2.

Press "Enter|Pause" to turn to the pause status.

Press and hold "Mode|Reset" for at least 1 second to switch from the label issuing mode to the function setting mode. At this point, the buzzer will sound and the "Ready" LED flashes to inform you that the printer has gone into the function setting mode (The Ready LED remains flashed while the printer is in the function setting mode.). Since the rotary switch is set to 2, function number2's current setting, 6, is indicated by the "Label" and "Com." LEDs. Read the setting as the sum of the values printed to the left of the LEDs. In this example, since 5 and 1 are lit, the setting is 5 + 1, or 6.

Turn on the power while pressing [Mode/Reset], and then you can enter the function setting mode, too.

To change the setting of function number 10 (Supply type), change the rotary switch setting to 10. Now the LEDs display the current setting of function number 10. Since the supply type is set to 1, the "Com." LED is lit.

Press " /Feed" 8 times to change the setting to 9 (Supply type 9). The LEDs blink to show that the function is being changed.

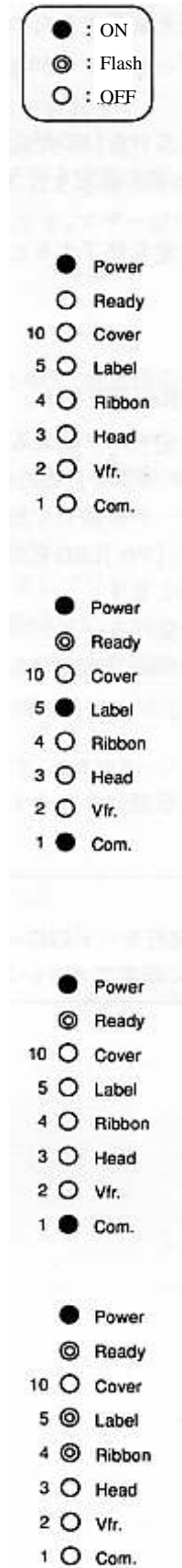

DURAPRINTER SR

Press "Enter|Pause" to change the setting. The buzzer makes a series of beeps to signal that the change has been made, and the LEDs that were blinking now light steadily.

To change other settings, repeat steps 1 to 4. To conclude function setting, go on to step 5 below.

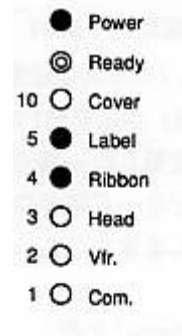

[Press "Mod|Reset".

The position of the rotary switch is automatically checked and the buzzer makes sounds intermittently in warning if a miss-return occurs.

The "Vfr." LED lights to show the setting to which the rotary switch should be returned.

Since the rotary switch is set to 2 upon entering the function setting mode, the "Vfr." LED lights.

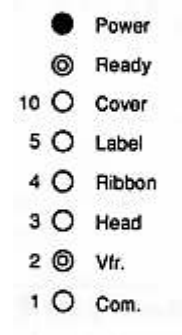

Upon setting the rotary switch to 2, the buzzer stops sounding, the LED goes out, and the printer enters the pause state. (To finish setting)

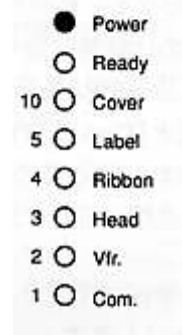

Note:

Printing may not work properly if the rotary switch (print density) is changed in the label issuing mode.

5-3-3. How to Select Functions

1. Turn the rotary switch to the desired function number. At this point, the setting is displayed by the LEDs from "Cover" LED to the "Com." LED.
2. The setting can be changed by pressing " | Feed" or " | Set TOF". If the selected setting is different from the current setting, the LEDs flash to show the setting (to let you know that the setting value is being changed).
3. The selected setting can be confirmed by pressing the "Enter|Pause" key for one second. The buzzer sounds and the LEDs display the setting stops flashing but remains lit.

5-3-4. To Exit the Function Setting Mode

When you press the "Mode/Reset" key while in the function setting mode, the buzzer sounds and the function setting mode is exited. At this point the "Ready" LED stops flashing and goes off.

5-3-5. Printing out the Function Number Settings

- Set DIP SW8 on the back panel to ON (changing to the continuous forms mode).
- Load the printer with continuous forms or direct thermal paper with a width of 1.97" to 3.94" (50 to 100 mm). (When using direct thermal paper, remove the ink ribbon from the printer.)
- To print out the function settings, turn on the power while pressing " /Set TOF" on the front panel.
- Continue pressing " /Set TOF " until the "Ready" lamp lights.
The function number settings are printed out.
- Return DIP SW8 on the back panel to OFF.

```
<<< DIP SW >>>
      1  2  3  4  5  6  7  8
      OFF OFF OFF OFF OFF OFF OFF OFF

<<< FUNCTIONS >>>
F00 : 05   F04 : 09   F08 : 01   F12 : 00
F01 : 05   F05 : 09   F09 : 01   F13 : 00
F02 : 02   F06 : 04   F10 : 01   F14 : 00
F03 : 03   F07 : 01   F11 : 00   F15 : 00

[ ROM VERSION : 01.02 95/03/07 ]

HEAD RESISTANCE (AVERAGE) = 0425 OHM
                      (MAXIMUM) = 0455 OHM
                      (MINIMUM) = 0399 OHM
```

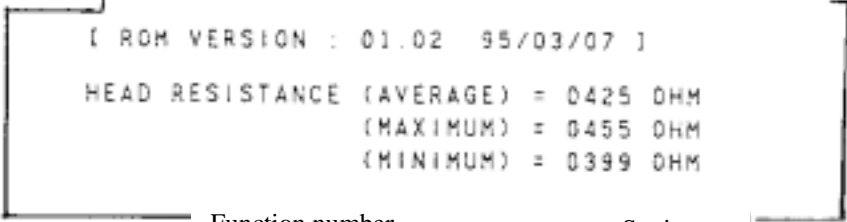

Example of function number setting printout

6. Functions of Individual Parts

6-1. Printer Initialization

- When the power is turned on, Memory is tested after initialization of the hardware (I/O), then head continuity is checked.
- **During the head test, the 6 error LEDs flash every 1.4 seconds and the buzzer goes on and off in a synchronous manner.**
- The verifier performs the restore movement (moves left and right horizontally).
- The top of form position is adjusted. (This operation varies according to the selected mode).
- Paper width is detected.
This completes printer initialization (The initialization operation takes about 14 seconds.).

6-2. Manual Length Measurement

When first using the printer or when changing label type (when changing the label length), use the learning function to determine the threshold value, label pitch and label length, and to confirm printer backup operation.

* Verification of the paper sensor threshold value, label length, and printer backup operation are and referred to as "measuring the length" combined together in the following explanation.

1. To measure label length by turning on / off the power switch. (White labels)

Move the label to be measured to between the head and the platen.

Turn on the power while pressing the "Enter/Pause" switch. (Press and hold the switch until the buzzer sounds).

After the buzzer sounds 3 times, the printer starts measuring the length.

The printer feeds 2 or 3 pages of labels.

When length measurement is completed, the sensor threshold value, the label pitch, and the label length are backed up. At that point, the buzzer sounds intermittently and the [Ready] LED flashes.

*When length measurement fails, the buzzer sounds continuously and LED for [5● Label] flashes.

In this case, start over again from step 2 above.

Turn off the power.

2. Pre-printed mode

When the pre-printed labels are used, measure the length following the method 1 or 2 below.

1) Length Measurement Method for Pre-printed Labels 1

Before measuring the length, make sure that the setting of function number 4 [Paper type and sensor type] is set to the number for "pre-printed labels".

Turn on the power with the cover open while pressing the "Enter/Pause" switch on the front control panel.

Both Power LED and Ready LED are lit and the buzzer sounds twice to indicate that the printer has become ready for the verification of the paper sensor threshold value.

Set the backing paper portion of the form to the detection position of the sensor and press [Enter/Pause].

Set the non-printed portion of the label to the detection position and press [Enter/Pause], just as in step .

The sensor verifies the light quantity level of the labels and that of the backing paper through steps④and⑤.

▪ When the difference between the level of the label and that of the backing paper is not less than the limit, the buzzer sounds continuously for a second.

▪ When the difference between the level of the label and that of the backing paper is less than the limit, the buzzer sounds intermittently to indicate that the difference between the levels is not enough and that the printer may not be able to detect the label edge properly..

Set the label between the thermal head and the platen roller and close the cover.

The buzzer sounds three times and the printer starts measuring the length and feeds 2 or 3 pages of labels.

When length measurement is completed, the sensor threshold value (gained through steps ④ and ⑤), the label pitch and the label length are backed up.

* When the length measurement ends successfully, the buzzer sounds intermittently and the Ready LED flashes. When the length measurement fails, the buzzer sounds continuously and the Label LED flashes. If this happens, start over again from the first step.

Turn off the power.

2) Length Measurement Method for Pre-printed Labels 2

Before measuring the length, make sure that the setting of function number 4 [Paper type and sensor type] is set to the number for “pre-printed labels”, and the setting for the function number 8 is 2.

Make up the labels for length measurement.

Cut out the unprinted portion of the label with scissors. Put 7 or more pieces of the cut out labels on the backing paper that is put at the detecting position of the sensor. Make the label pitch near the original one (need not to be accurate).

Set the labels for length measurement made in step between the thermal head and the platen roller.

Turn on the power while pressing the [Enter/Pause] switch (Hold down the switch until the buzzer sounds.).

The buzzer sounds three times and the printer starts measuring the length and feeds 2 or 3 pages of labels.

When length measurement is completed, the sensor threshold value is backed up. At this point, the buzzer sounds intermittently and the [Ready] LED flashes.

* When the length measurement fails, the buzzer sounds continuously and [5● Label] LED flashes.

In this case, start over again from step above.

Turn off the power.

The pre-print part must not be on the top end of sensor detecting part of label to be printed.

The paper sensor can not detect the label, correctly.

Use the label which does not have pre-print part more than 3mm from the top of label.

(The following figure shows the case of center fixed sensor use)

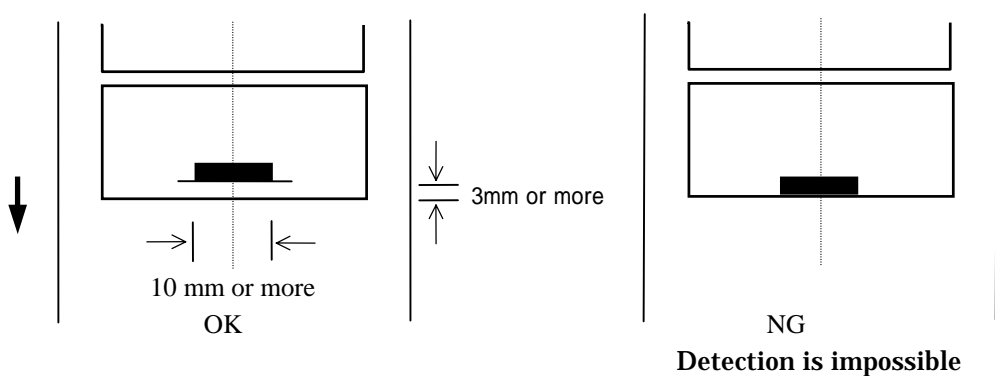

6-3. Back Panel DIP Switch Settings (for the RS-232C Interface)

DIP SW	Function	OFF		ON
1 2	Baud Rate	DIPSW1	DIPSW2	Baud Rate
		OFF	OFF	9600
		OFF	ON	9600
		ON	OFF	4800
ON	ON	2400		
3	Data Length	8 bits		7 bits
4	Parity	EVEN		ODD
5	Stop Bit	1 bit		2 bit
6	Flow Control	RTS/CTS		XON/XOFF
7	Framing Error	Available		Not Available (Normal)
8	Labels / Continuous Paper	Labels		Continuous Paper

The RS-232C settings can be changed only with these DIP switches.

 Factory setting

6-4. Paper Detection Sensors

Paper sensor voltage selector switch

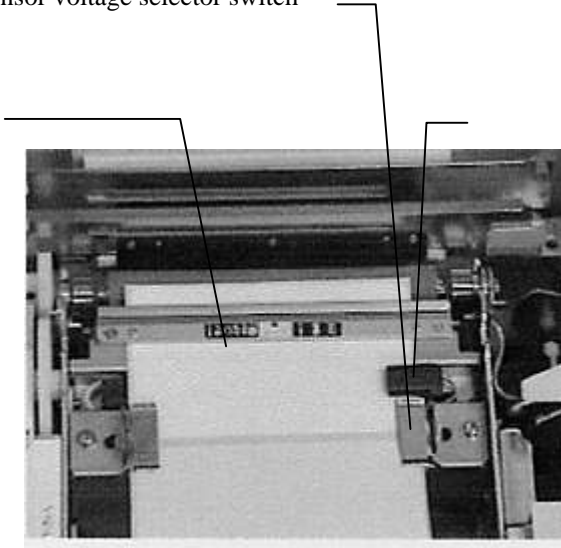

Fig.10-1

Interruptive-type center sensor (Fixed)

This sensor detects gaps between forms (breaks in the backing paper) and detects center holes (This sensor provides the best paper feed accuracy.).

②Interruptive-type form edge sensor (movable)

This sensor detects gaps between forms (breaks in the backing paper), and notches in the edge of forms (This sensor provides paper feed accuracy that is inferior to that of sensor ① described above.).

Adjust the position of the sensor so that labels pass through the gap of the sensor.

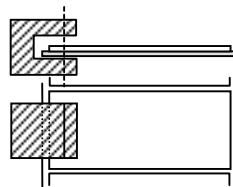

6-5. Paper Sensor Voltage Selector Switch

The paper sensor voltage selector switch is located under the printer cover. Set the switch according to the type of separator (backing) used, then perform length measurement.



Fig.10-2

Blue glassine paper—Blue
Transparent PET paper—Clear
White PET paper—White

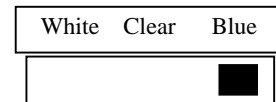

Note:
Only for interruptive-type center sensor.

7. Loading Labels/Tags

Specified labels are used for this printer. Note that if you use any other labels, the printing may not function properly.

Load roll paper onto the roll paper holding plate

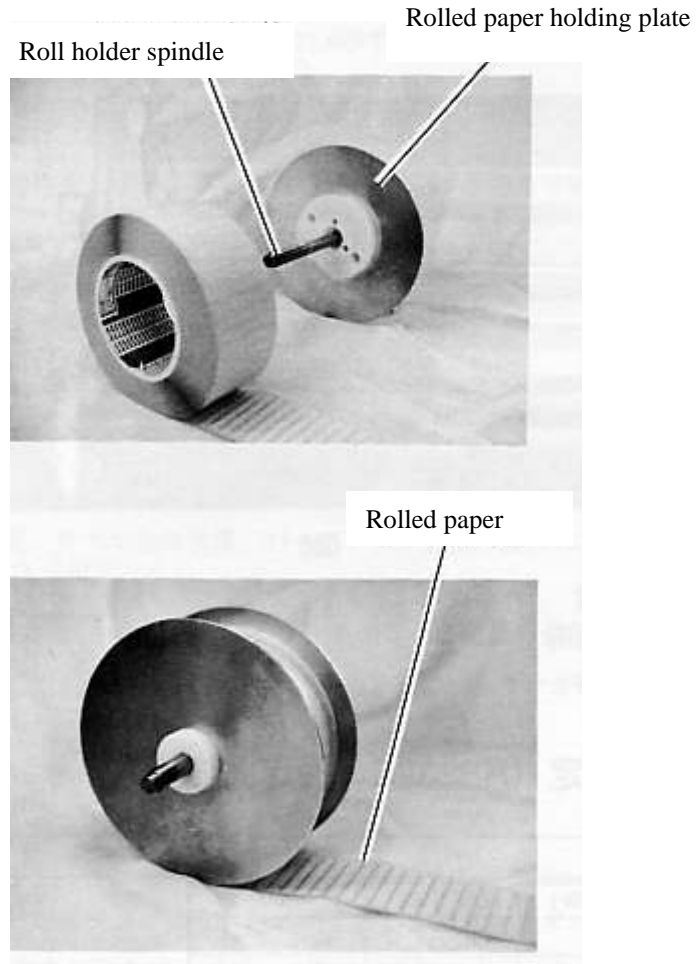

- The roll holder spindle is marked with index markings. Position the holder plates so that the label roll is positioned at the center of the spindle.

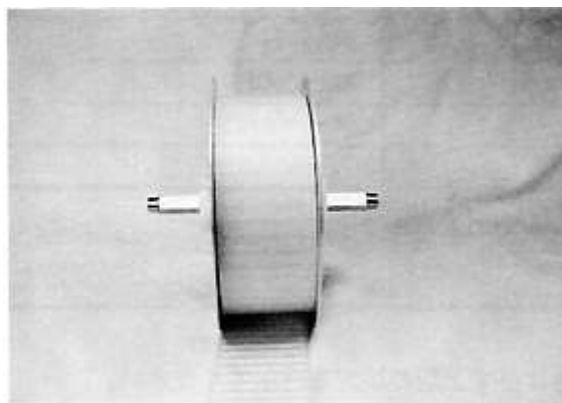

Fig.11

Open the top cover and attach the left and right side of the rolled paper holding plate into the holder receptacle in the main body.

Note:

When loading or replacing labels/tags, the roll holder plates may fall off of the core of the label/tag roll. Be sure to hold the roll holder plates in place with both hands when loading the labels/tags. Dropping one of the roll holder plates on the thermal head can damage the head.

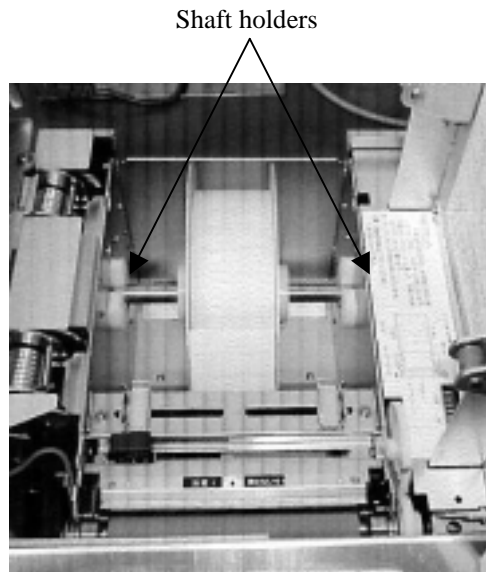

Fig.12

Spread the paper guides wider than the width of the label, and then load the labels/tags by threading them through the paper guide and the sensors, until the labels/tags reach the platen roller. Push the paper guides towards the center until they touch both edges of the label. Close the top cover.

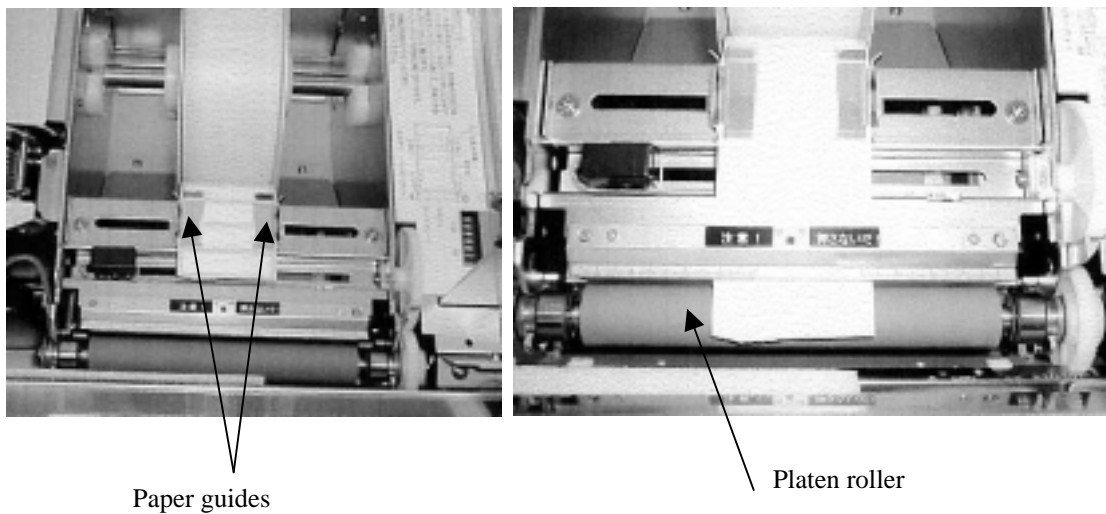

Fig.13

8. Loading Ribbon

8-1. Loading Ribbon

Insert the ribbon roller gear unit in a ribbon core. Position the ribbon core at the center of the ribbon roller gear unit.

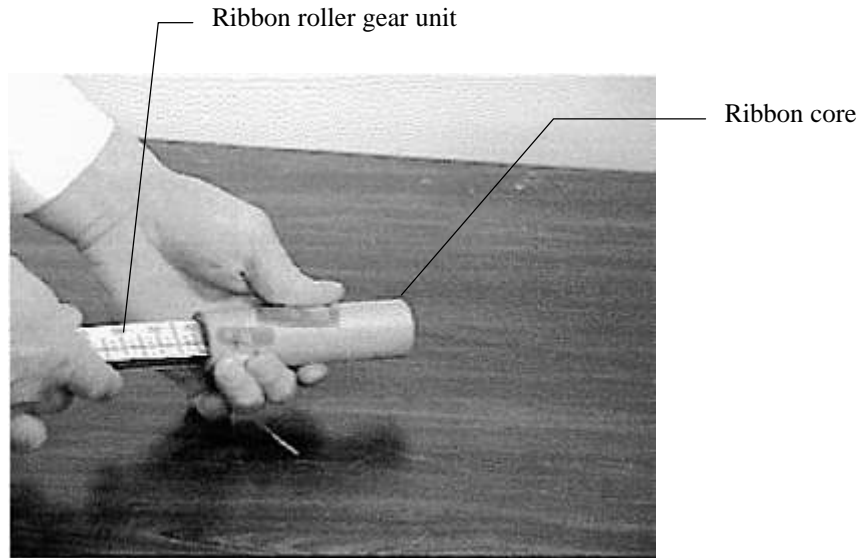

Fig.14

Open the top cover of the printer.

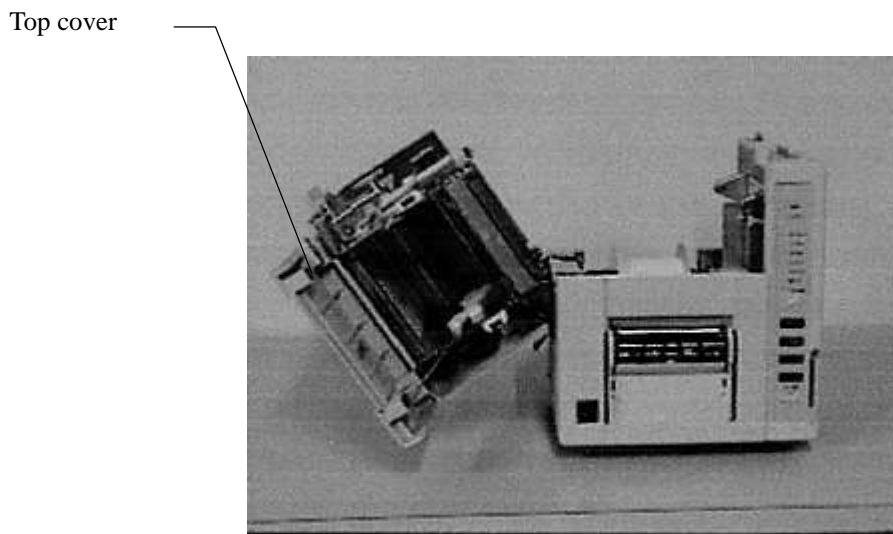

Fig.15

Insert the ribbon roller gear unit in a new ribbon (supply ribbon) core so that the new ribbon core is positioned at the center of the ribbon roller gear unit, just as in step .

Push the ribbon roller gear unit into the shaft holder on the top cover until it locks in place.

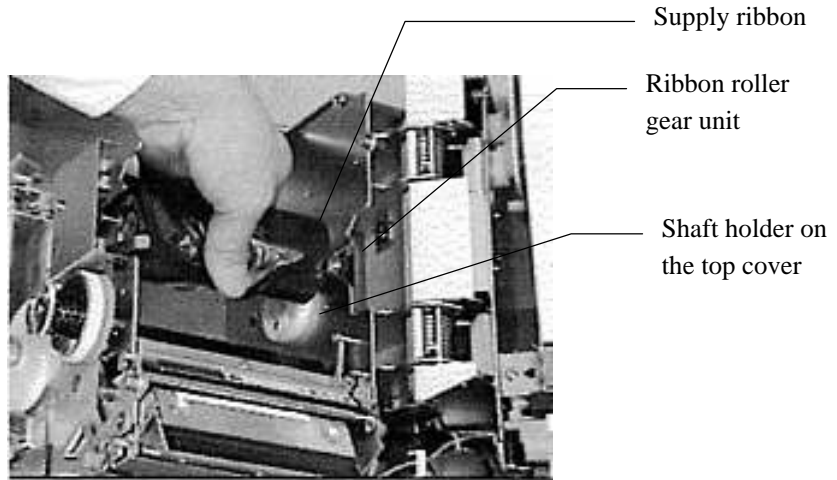

Fig. 16

Take the ribbon roller gear unit with a ribbon core on it that was prepared in step , and place it in the v-shaped notches on the top cover. Then lift up the leader tape on the supply ribbon and attach it to the ribbon core.

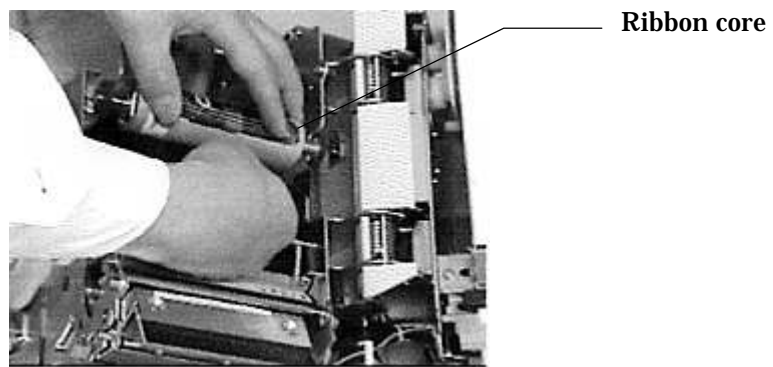

Fig.17

⚠ Caution:

The thermal head may be hot. When loading a ribbon, be careful not to touch the thermal head.

⚠ Caution Print head is hot

This caution label is located near the thermal head.

DURAPRINTER SR

Push the roller gear unit (the one with the ribbon core on it and the leader tape is attached) into the take-up ribbon shaft holder on the top cover until the roller gear unit clicks into place.

Take-up ribbon
shaft holder

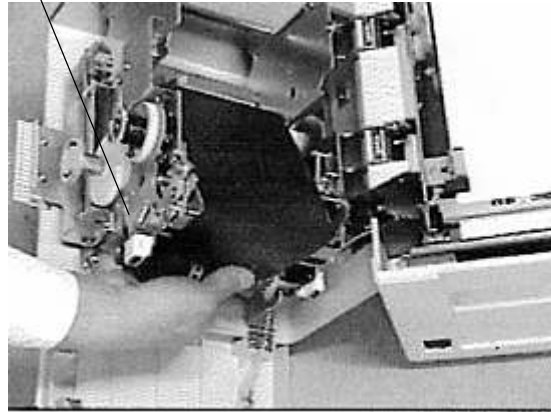

Fig.18

Turn the take-up knob counterclockwise to take up the slack in the ribbon.

Take-up knob

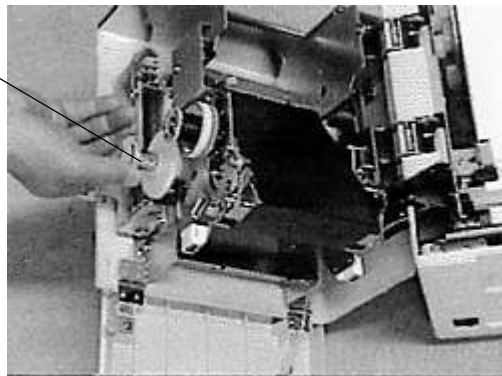

Fig.19

8-2. Replacing Ribbon

Grasp the used ribbon, and pull the ribbon roller gear unit out of the take-up ribbon shaft holder on the top cover of the printer.

Used ribbon

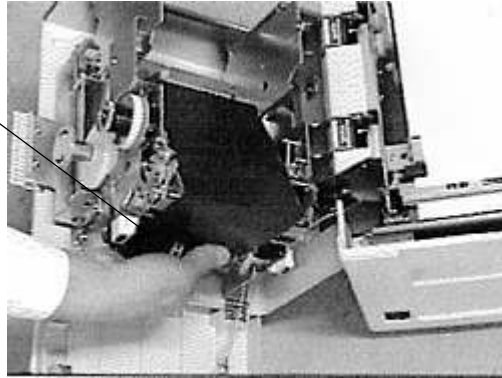

Fig.20

Pull out the ribbon roller gear unit from the used ribbon.

Ribbon roller
gear unit

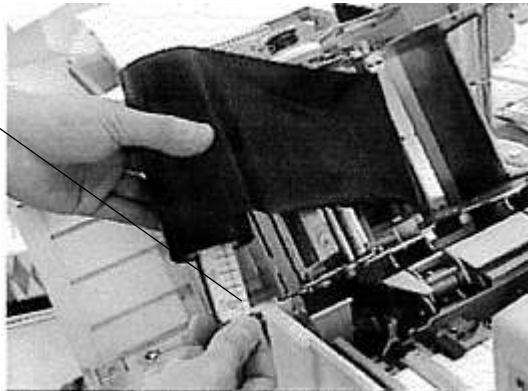

Fig.21

Use the empty supply ribbon core as the next take-up ribbon core.

Note:

If the front cover is opened and closed frequently while the ribbon take-up diameter is large, the ribbon that has been taken up may begin to lean too much to one side, making it difficult to remove when replacing the ribbon. In this event, pull the ribbon back towards the center and then remove it.

9. Changing the Thermal Head Pressure

⚠ Caution:

Turn the power off before performing this procedure.

● Note that the thermal head may still be hot even if the power has been turned.

⚠ Caution Print head is hot. This caution label is located near the thermal head.

If the labels are less than 2"(50mm) wide, hold down the heating element side of the thermal head with your finger and insert the thermal head pressure changing plate under the two discs.

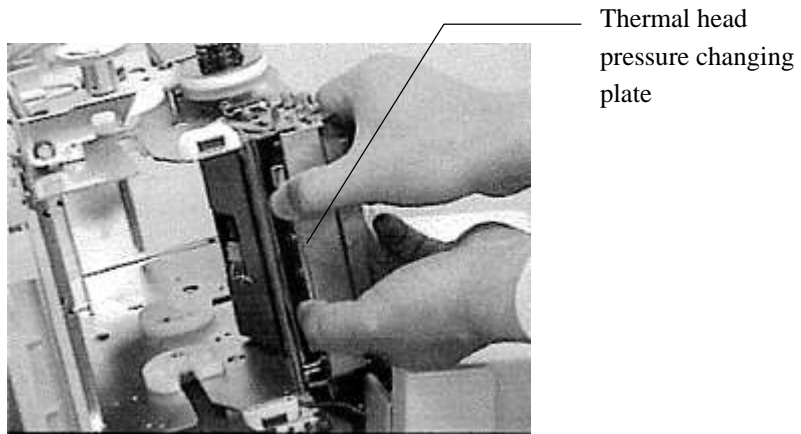

Fig.22

If the labels are 2"(50mm) or more wide, hold down the heating element side of the thermal head with your finger and remove the thermal head pressure changing plate under the two discs.

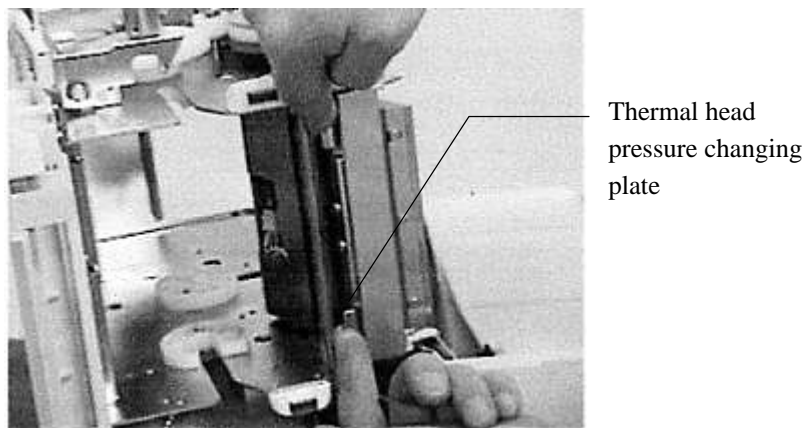
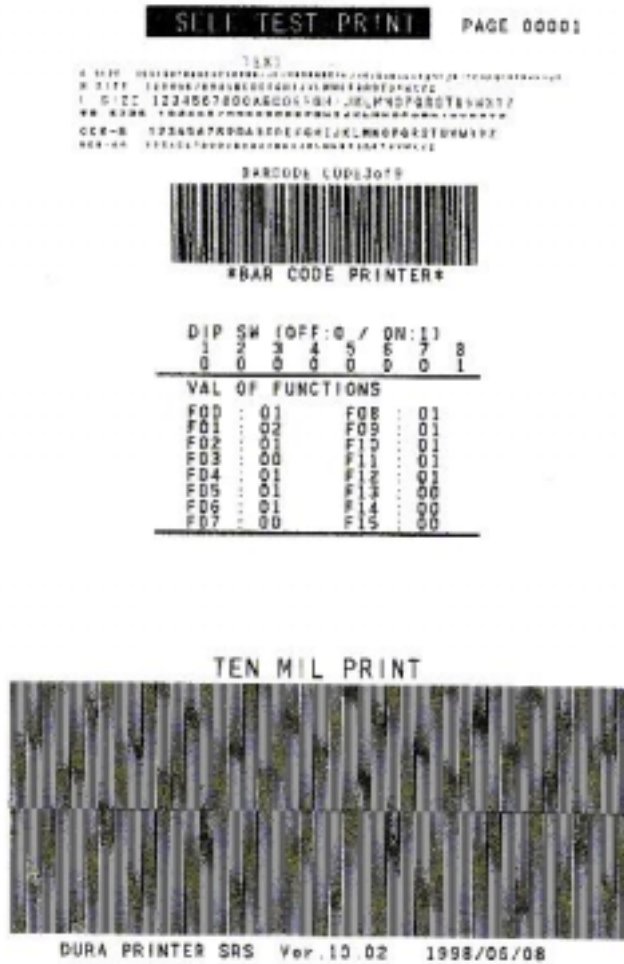

Fig.23

10. Test Printing

The test printing procedure is described below. When installing the printer, always be sure to perform a test print once before connecting the printer to the computer.

- Set DIP SW8 on the back panel to ON (to put the printer in the continuous forms mode).
- Load the printer with continuous forms or direct thermal paper with a width of 3.99” to 4.33” (100 to 110mm).
(Remove the ink ribbon from the printer when you use the direct thermal paper.)
- To initiate test printing, turn on the power while pressing the [↑ /Feed] key.
- Continue pressing the [↑ /Feed] key until the [Ready] LED lights.
- To end test printing, press the [Enter/Pause] switch and then turn off the power.
- Return DIP SW8 on the back panel to OFF.



Example of Test Print

11. Maintenance

In order to keep the printer operating in peak condition for a long time, be sure to perform the maintenance described below. If these maintenance procedures are not performed, the printer will not be covered by its warranty.

Caution

- When performing maintenance and inspections, be sure to turn both the printer and the computer off, and disconnect the power cords from the power outlets.
- Use isopropyl alcohol, methanol, ethanol, or the cleaning cloth included in the carton to clean the thermal head, platen rollers, and form sensors. Using other solvents could damage the components. Handle isopropyl alcohol and methanol carefully, as both are flammable. Also, do not attempt to clean the thermal head while it is hot.

Note:

- ① Use the cleaning cloth included in the carton or a clean and previously unused cloth when cleaning. Never use chemical cleaning cloths.
- ② If you will be touching the inside of the printer, remove any precious metals or gloves from your hands. Be careful not to scratch the thermal head with any metallic buttons, rings, bracelets, or other metallic objects.
- ③ Do not apply any lubricants to any part of the printer. Lubricants are applied at the factory, and do not need to be applied by the user.
- ④ Do not spray any solvent, cleaning solution, or anything else onto, into or around the printer. If spray gets into the printer, damage may result.

11-1. Cleaning the inside of the Printer

Caution:

Be sure to turn the power off first.

The inside of the printer should be cleaned after every 985ft(300m) of labels. (In other words, after using one standard 985ft ribbon.)

Clean the following locations:

Paper guides, platen roller, output slot paper guide, paper sensors, ribbon peeler (the stainless cover), ribbon take-up bar, thermal head, and verifier.

Turn the power off, disconnect the power cord from the power outlet, open the top cover of the printer, remove the labels and ribbon, and then clean the locations listed above with a clean cloth dampened with isopropyl alcohol, methanol, or ethanol.

Cleaning the Paper Guide

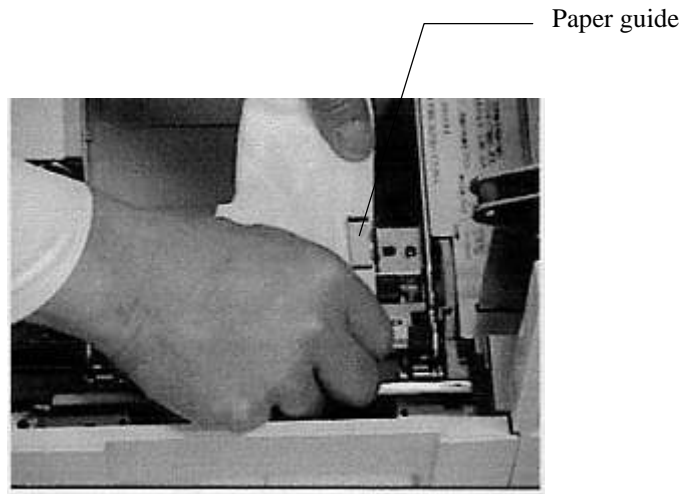

Fig.24

Cleaning the Platen Roller

Clean while turning the gears manually.

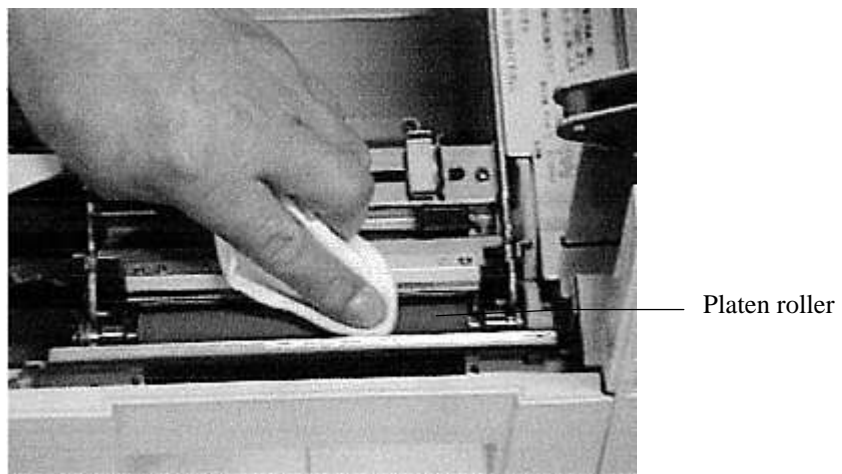

Fig.25

Cleaning the Output Slot Paper Guide

Pull out the output slot paper guide and remove the dirt and dust.

Cleaning the Paper Sensor

The sensor located between the paper guide and the platen roller through which the labels pass is a Interruptive-type sensor. Pass a cloth dampened with alcohol through the region where the labels pass and then move the cloth back and forth several times to clean the sensor.

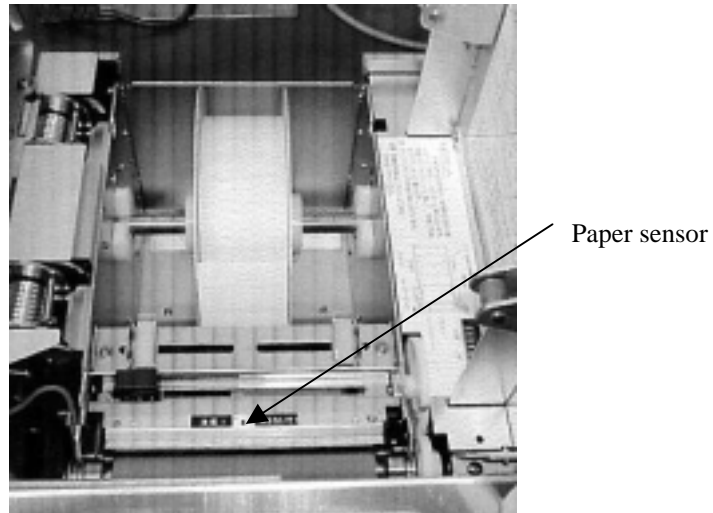

Fig.26

Cleaning the Ribbon Peeler

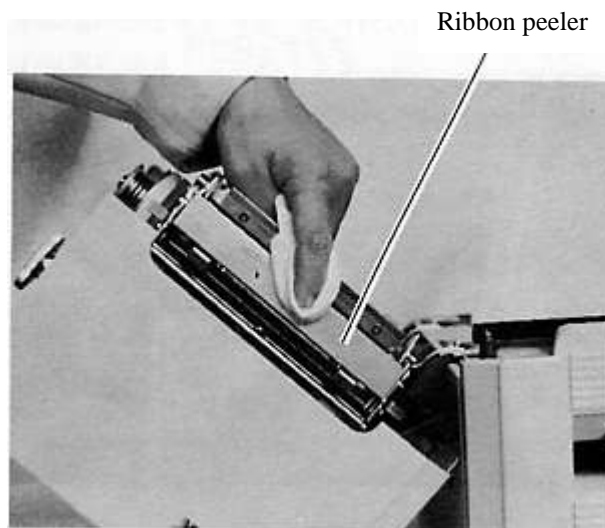

Fig.27

Cleaning the Ribbon Take-up Bar

Ribbon take-up bar

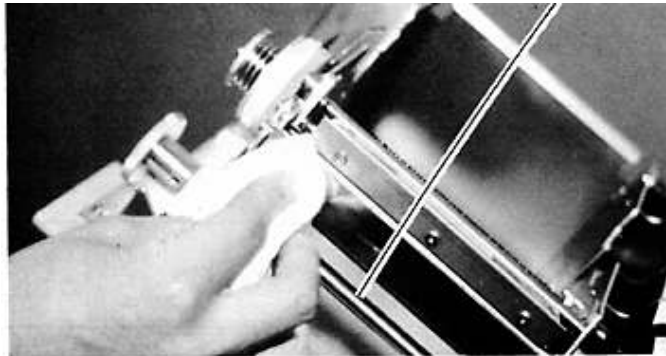

Fig.28

Cleaning the Thermal Head

Caution:

Note that the thermal head may still be hot even if the power has been turned off.



This caution label is located near the thermal head.

Thermal head



Fig.29

Cleaning the Verifier

Remove the paper guides from the label output slot. Insert the cotton swab into the label output slot and clean the end of the pen scanner. Open the top cover and remove the dust such as the broken pieces of the labels in the verifier unit if any.



Fig.30

11-2.Removing the Interruptive-type Center Hole Sensor

If a label accidentally sticks to the bottom portion (tunnel portion) of the Interruptive-type center sensor, remove the Interruptive-type center hole sensor as described below and remove the label.

Use a coin or flat-blade screw driver to remove the left and right screws holding the Interruptive-type center hole sensor in place.

Interruptive-type
center sensor

Screw

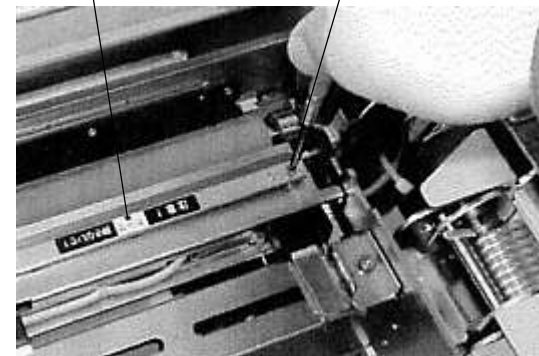

Fig.31

Remove the Interruptive-type center hole sensor unit and then remove the label.

Interruptive-type
center hole sensor

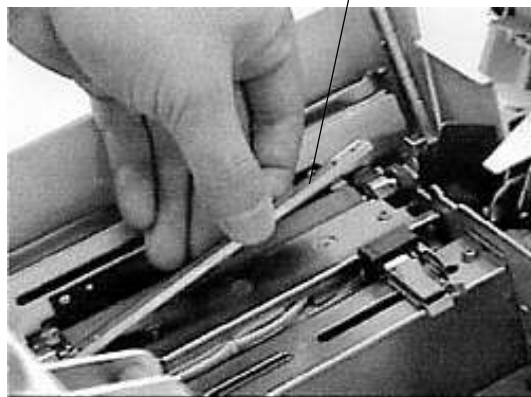

Fig.32

Re-attach the Interruptive-type center hole sensor unit by reversing step , and then use a coin to tighten the left and right screws.

12. Replacing Components

12-1. Replacing the Thermal Head

After being used for a long period of time, the thermal head may reach the end of its operational life, which will manifest itself through a deterioration in print quality resulting from broken wiring in the thermal head (resulting in white vertical lines), blurred bar codes and text, etc. It is then necessary to replace the thermal head in order to maintain the print quality. The thermal head replacement procedure is described below. (The thermal head is considered to be a consumable component.)

Turn the power switch off, open the top cover, and remove the ribbon on the take-up side.

⚠ Caution:

Note that the thermal head may still be hot even if the power has been turned off.

⚠ Caution Print head is hot.

This caution label is located near the thermal head.

Press the left and right release levers, and remove the thermal head.

Release lever

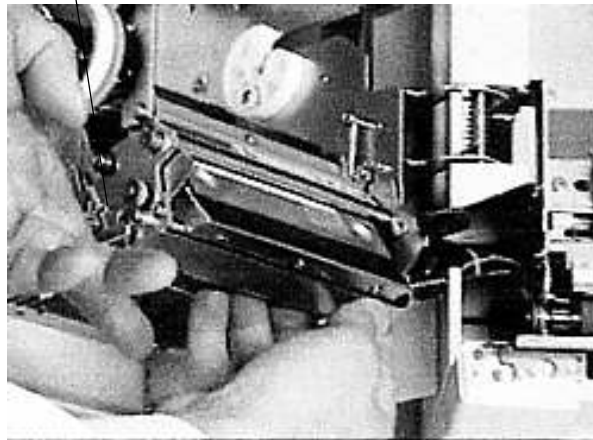

Fig.33

Disconnect the two connectors on the thermal head and then remove the thermal head from the printer.

Connectors

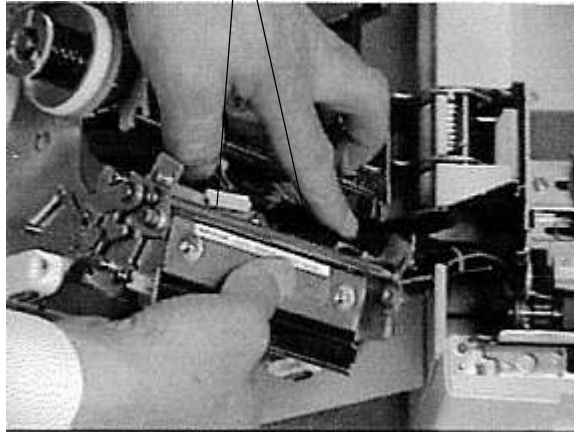

Fig.34

Being careful not to scratch it, connect the connectors to the new thermal head.

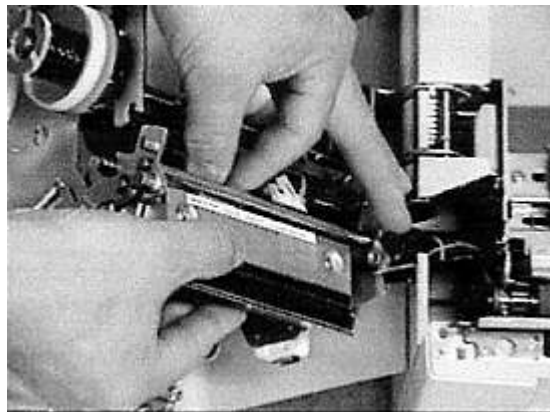

Fig.35

Note:

- When connecting and disconnecting the connectors, make sure to match the polarity and the positioning of the connectors first. Also, be careful not to bend the connector pins.

After setting the thermal head bracket into the guide holes in the printer, push the thermal head in until it locks in place. Be careful not to bend the ribbon peeler.

Guide Holes in Printer

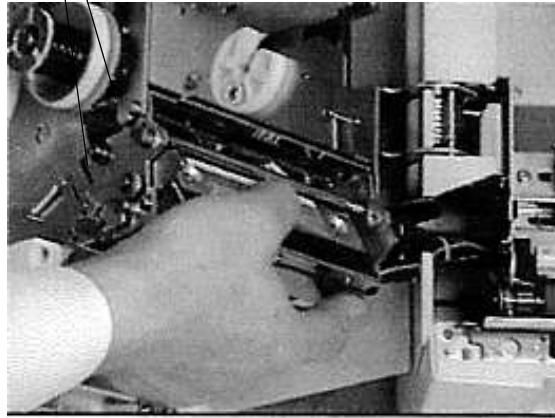

Fig.36

Note:

- When replacing the thermal head, be careful not to scratch the new thermal head or get it dirty.
- When replacing the thermal head, be careful not to touch the heating element surface with your fingers.
Sweat on your fingers will contain salt, which could corrode the protective film on the surface of the thermal head. If you do accidentally touch the surface, clean it immediately
- After installing the thermal head, wipe it gently.

12-2. Replacing the Platen Roller

After being used for a long period of time, wear on the platen roller may result in deterioration in print quality, such as blurred bar codes and text, etc. It is then necessary to replace the platen roller in order to maintain the print quality. The platen roller replacement procedure is described below. (The platen roller is considered to be a consumable component.)

Remove the output slot paper guide.

Press down the release levers at the left and right ends of the platen roller and remove the platen roller. (Remove the end with the gears first.)

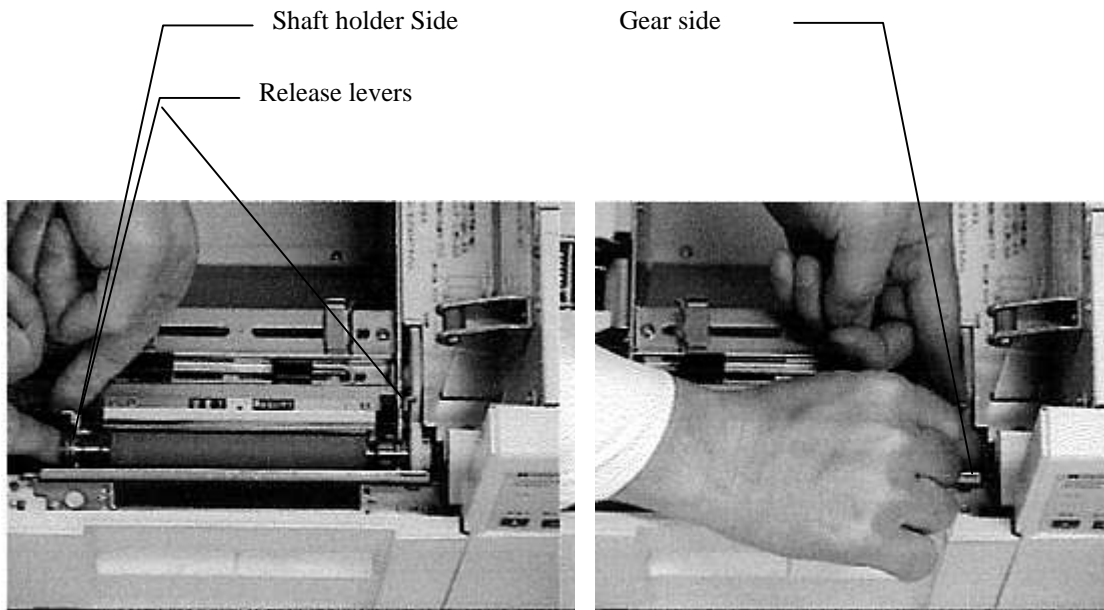

Fig.37

Install the new platen roller.

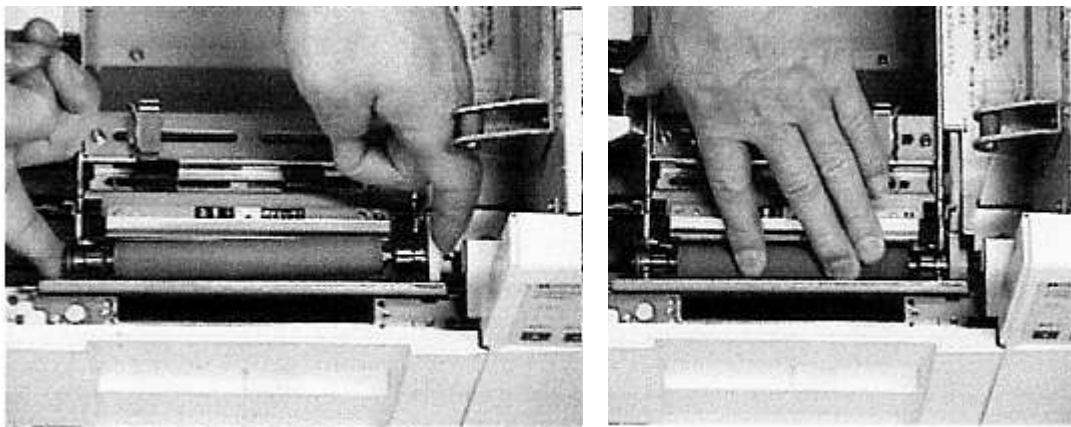

Fig.38

12-3. Replacing the Fuse

Turn the fuse holder cap counterclockwise with a coin and pull out the fuse.

After removing the old fuse, push a new fuse into place. (One replacement fuse is included with the printer.)

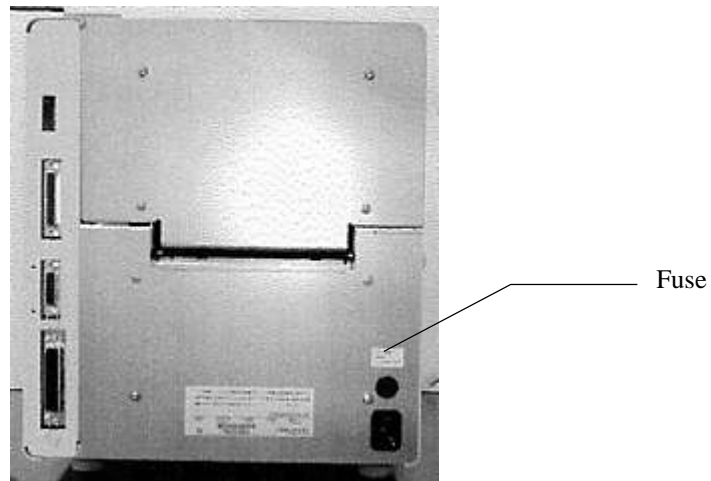

Fig.39

⚠ Caution:

Replace the fuse only with the a fuse of the same type and ratings.

Using a different fuse could result in a fire.

The ratings for the fuse are:3.15A time lag 250V AC.

13. Troubleshooting

This chapter describes checkpoints and procedures to follow if you experience trouble with the printer.

Error Display Lights

Symptom	Remedy
The power indicator does not light up when the power switch is turned on.	<ul style="list-style-type: none"> ▪ Verify that the power cable is securely connected to the printer. ▪ Check whether the printer's fuse is blown. If a new fuse blows soon after you turn on the power, contact your dealer for assistance.
"Cover" LED is lit.	<ul style="list-style-type: none"> ▪ The top cover is open. Close it properly.
"Label" LED is lit.	<ul style="list-style-type: none"> ▪ The label is missing. Load a label into the printer.
"Label" LED is flashing.	<ul style="list-style-type: none"> ▪ A label jam has occurred. Remove the jammed labels. ▪ Label length is not correct. Measure the label length following the procedure described in 6-2.
"Ribbon" LED is lit.	<ul style="list-style-type: none"> ▪ The ribbon is missing. Load a ribbon into the printer.
"Head" LED is lit.	<ul style="list-style-type: none"> ▪ The thermal head is damaged. Replace it with a new one. ▪ Turn on the power while pressing both [Mode/Reset] and [Set TOF] together, the head error is cleared temporarily. ▪ When the cover sensor is closed while the verifier is inactive, "Head" LED is lit if the front cover interlock switch is OFF. Check the front cover interlock switch. ▪ "Head" LED may be lit when PSU (power supply) is under abnormal conditions.
"Com." LED is lit.	<ul style="list-style-type: none"> ▪ The communication conditions set for the printer do not match those of the connected computer. Check settings of the computer. ▪ After changing the settings, press the [Mode/Reset] switch, then resend the data from the computer. ▪ Momentarily power off the printer, then try sending again.
"Vfr." LED is lit.	<ul style="list-style-type: none"> ▪ Make sure that the output slot paper guides are properly installed. ▪ Clean the verifier. ▪ Change the selection of the supplied material type, or the density switch selection to make them appropriate. ▪ Make sure that a suitable quiet zone (blank area) is being maintained on the left and right sides of the labels. ▪ Check whether the barcode is out of position above or below the labels.
"Label" LED and "Vfr." LED are lit at one time..	<ul style="list-style-type: none"> ▪ Verifier hard error Verifier hard error or malfunction of front cover interlock switch is detected. ▪ Verifier hard error. Clean the verifier unit. When the verifier unit is out of order, it must be replaced. Contact with the dealer. (You can operate the printer without operating the verifier. Turn on the power while pressing the [Mode/Reset] to enter the function setting mode and change the setting of function number 3 (Verifier active) from 3 (Verifier

	<p>active) to 4 (Verifier inactive).)</p> <ul style="list-style-type: none">▪ Malfunction of front cover interlock switch <p>Check whether the front cover interlock switch is OFF while the cover sensor is closed.</p>
--	----------------------------------------------------------------------------------------------------------------------------------------------------------------------------------------------------------------------------------------

LED lighting patterns

Front panel LEDs (in label issuing mode) Errors	Cover	Label	Ribbon	Head	Vfr	Com.	Buzzer Sound
Cover open	●	○	○	○	○	○	No buzzer
Label end	○	●	○	○	○	○	Single LED errors: Intermittent beeping
Label jam	○	◎	○	○	○	○	
Ribbon end	○	○	●	○	○	○	
Head discontinuity Note1)	○	○	○	●	○	○	
Multiple Voids	○	○	○	○	●	○	
Communication Error	○	○	○	○	○	●	
Command error (RCL+)	○	○	○	●	○	●	Combination LED errors: Continuous beeping
Command error (Data)	○	○	●	○	○	●	
Verifier hard error Note2)	○	●	○	○	●	○	
Verifier time out	○	○	●	○	●	○	
Verifier communication error	○	○	○	●	●	○	
Memory card error	○	●	●	○	●	○	
Memory card low battery	○	●	●	○	○	●	
EEPROM error (parallel)	○	○	●	●	○	●	
EEPROM error (serial)	○	○	●	●	●	○	
ROM error	○	●	●	●	●	○	
RAM error	○	●	●	●	○	●	
Main controller	●	●	●	●	●	●	

* ● : Lit ○ : Off ◎ : Flashing

* The Power LED does not light in the event of a main controller error.

* The buzzer does not beep if it is turned off.

* The LEDs do not display error information while in the function setting mode (while the Ready lamp is flashing). Make sure that the printer is in the label issuing mode (that the Ready lamp is off).

* Intermittent beeping indicates one or more single LED errors.

For example, if both the Ribbon and Com. LEDs are lit and the buzzer is sounding intermittently, both ribbon end and communication errors have occurred.

When the buzzer sounds continuously, an LED combination error is indicated.

For example, if both the Ribbon and Com. LEDs are lit and the buzzer is sounding continuously, a command error has occurred.

Note1), Note2) Check the front cover interlock switch, too (See the previous page.).

Printing Does Not Function Properly

Symptom	Possible Cause	Remedy
Test printing does not work.	<ul style="list-style-type: none"> ▪ The Form Feed switch ([↑ /Feed]) is not pressed. 	<ul style="list-style-type: none"> ▪ Turn on the power while pressing the form feed switch ([↑ /Feed]).
The printer does not print.	<ul style="list-style-type: none"> ▪ The ribbon is installed backwards or the ribbon is not installed. ▪ The power switch is not ON. ▪ The communication cable has connection problems, or is disconnected. ▪ The selection of the supplied material type is wrong, or the density switch selection is wrong. ▪ The printer is not ready. 	<ul style="list-style-type: none"> ▪ Properly re-install the ribbon, so that the inked side faces out (the surface). ▪ Connect the power cable and turn on the power switch. ▪ Replace the communication cable. ▪ Change the selection of the supplied material type, or the density switch selection to make them appropriate. ▪ Press [Enter/Pause], and then Ready LED is lit.
Print quality is poor, or something is wrong with the ribbon.	<ul style="list-style-type: none"> ▪ The supplied material has been changed ▪ The supplied material other than the specified one is used. ▪ The platen roller is worn out. ▪ The thermal head is worn out. ▪ The ribbon is creased. ▪ The ribbon is not installed straight. ▪ The ribbon type is wrong, or the density switch selection is wrong. ▪ The paper guide is not installed properly. 	<ul style="list-style-type: none"> ▪ Change the Print Density setting to a higher value. ▪ Change over to the specified supplied material. ▪ Replace the platen roller. ▪ Replace the thermal head. ▪ Re-install the ribbon without creasing it. ▪ Re-install the ribbon properly. ▪ Change the selection of the supplied material type, or the density switch selection to make them appropriate. Make the print speed slower. ▪ Make the paper guide touch the paper properly. Set the paper guide correctly so that there leaves no space between the paper guide and the paper.

APPENDIX A Basic Specifications

1. Printing method	Thermal ink-transfer printing	
2. Print head dot density	400dpi(15.75dot/mm)	
3. Maximum printing speed	1.34inch/sec(35mm/sec)	
4. Maximum printing width	3.84”(97.54mm)(1536dot)	
5. Maximum printing length	3.94”(100mm)	
6. Page width	0.98-4.33”(25-110mm)	
7. Page length	0.12”-3.94”(3-100mm)	Cutter machine 0.98”(25mm) or more
8. Page thickness	0.005”-0.0098”(0.12~0.25mm)	
9. Internal paper roll	(1) Winding direction : Printing surface outside/inside	
	(2) Paper roll outer diameter	: ϕ 5.90”(150mm) or less
	(3) Paper tube inner diameter	: ϕ $3^{+0.08}_{-0.04}$ inches (76.2 $^{+2}_{-1}$ mm)
10. Fanfold forms	Page pitch : 2.76”(70mm or more)	Fanfold forms are placed outside the printer. Print quality is not guaranteed in a 0.08” (2mm) region before and after perforations.
11. Form sensor types	(1) Interruptive-type form edge sensor (movable)	Detects notches in the forms
	(2) Interruptive-type center sensors (fixed)	Detects backing paper and center hole
12. Ribbon width	1.57” - 4.72”(40-120mm)	At least 0.39” (10mm) wider than the forms
13. Supply ribbon roll	(1) Winding direction :	Ink on the outside
	(2) Paper tube inner diameter :	ϕ $1^{+0.04}_0$ inch (25.4 $^{+1}_0$ mm)
	(3) Length of ending silver tape :	5.91” (150mm) or more
	(4) Winding dimension :	ϕ 2.76”(70mm) diameter or less
	(5) Ribbon length :	985ft (300m) (reference value)
14. Type of barcode	(1) UPC/EAN/JAN (2) CODE39 (3) CODABAR(NW-7) (4) ITF (5) CODE128 (6) CODE93 (7) CASECODE128	
15. Minimum narrow element width	0.005”(0.127mm)	

DURAPRINTER SR

- 16.Barcode rotation 0° , 90° , 180° , 270°
- 17.2-D symbol (1)PDF417
(2)QR
(3)Data Matrix(ECC200)
- 18.Type of characters,
 Symbols (1)Dot font
 ▪ XS,SS,S,M,L,B,N1,N2,NO1,NO2,
 NO3,NO4,NO5,NA1,NA2 (Alphanumeric, 1Byte codes)
 ▪ OCR-B (Alphanumeric, 1Byte code)
 ▪ JISkatakana code (16 × 16 dots, 1Byte code)
 ▪ Kanji first and second level gothic fonts (Japanese)
 (2Byte code)
 (16 × 24 dots、 24 × 24 dots)
(2)Vector font
 Rotatable font, Tipton (Alphanumeric, 1Byte code)
(3)Outline font (Japanese), Option
 Gothic type outline font Kanji first and second level code (2Byte code)
- 19.Character magnification (1)Dot font
 1-16 times
(2)Rotatable font
 Width : 0.025"-4.16" (0.635-105.6mm)
 Height : 0.05"-7.87" (1.27-200mm)
(3)Tipton gothic font
 Width : 0.05"-2.5" (1.27-63.5mm)
 Height : 0.1"- 3.3" (2.54-83.8mm)
- 20.Character rotation 0° , 90° , 180° , 270°

DURAPRINTER SR

21.Host I/F	Parallel (Centronics conforming) Serial (RS232C)		
22.External Dimensions	Height	330mm (13.0 inches)	
	Width	290mm (11.4 inches)	
	Depth	300mm (11.8 inches)	
23.Weight	less than 19Kg (41.8 lbs)		
24.Power consumption	150W		
25.Input power	230V AC 50HZ		
26.Operating temperature and humidity requirements	41 to 950F (5 to 35°C) 10 to 85%RH		
27.Options			
-1.External role holder	Field option	Model number	: RH-63
		Roll diameter	: No more than ϕ 9.84" (ϕ 250mm)
-2.Memory card	Field option		
-3.Outline font (Japanese)	Factory option		

APPENDIX B Serial Interface

This printer comes equipped with a serial communication port on the right side wall.

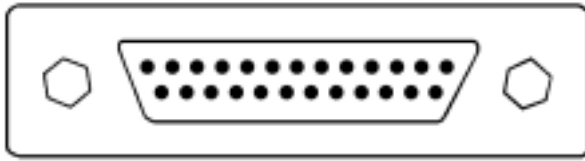

Serial port

Receive Buffer Capacity

2k bytes

Serial Communication Control

When the receive buffer free capacity changes from 257 bytes to 256 bytes, the send halt signal is sent. When the remaining data in the receive buffer changes from 17 to 16, the send start signal is sent.

Serial Interface Specifications

The serial interface port supports data communications with a host computer.

Communication protocol:

DIP SW	Function	OFF	ON															
1 2	Baud rate	<table border="1"> <thead> <tr> <th>DIP SW1</th> <th>DIP SW2</th> <th>Baud rate</th> </tr> </thead> <tbody> <tr> <td>OFF</td> <td>OFF</td> <td>9600</td> </tr> <tr> <td>OFF</td> <td>ON</td> <td>9600</td> </tr> <tr> <td>ON</td> <td>OFF</td> <td>4800</td> </tr> <tr> <td>ON</td> <td>ON</td> <td>2400</td> </tr> </tbody> </table>		DIP SW1	DIP SW2	Baud rate	OFF	OFF	9600	OFF	ON	9600	ON	OFF	4800	ON	ON	2400
		DIP SW1	DIP SW2	Baud rate														
		OFF	OFF	9600														
		OFF	ON	9600														
ON	OFF	4800																
ON	ON	2400																
3	Data length	8 bits	7 bits															
4	Parity	EVEN	ODD															
5	Stop bit	1 bit	2 bits															
6	Flow control	RTS/CTS	XON/XOFF															
7	Framing error	Available	Not available (Normal)															
8	Labels / Continuous form	Labels	Continuous form															

The following diagram illustrates various interface configurations that this printer supports.

Pin No.	Signal
2	Transmit
3	Receive
4	RTS
5	CTS
6	DSR
7	Signal ground
20	DTR

DURAPRINTER SR

The diagram below shows the necessary interface cable connections for serial communications between this printer's serial port and a host, which follows RTS/CTS (hardware) handshaking protocols.

Connect the cable correctly, or the printer error may occur when a lot of data are continuously sent.

- A personal computer with 9-pin socket

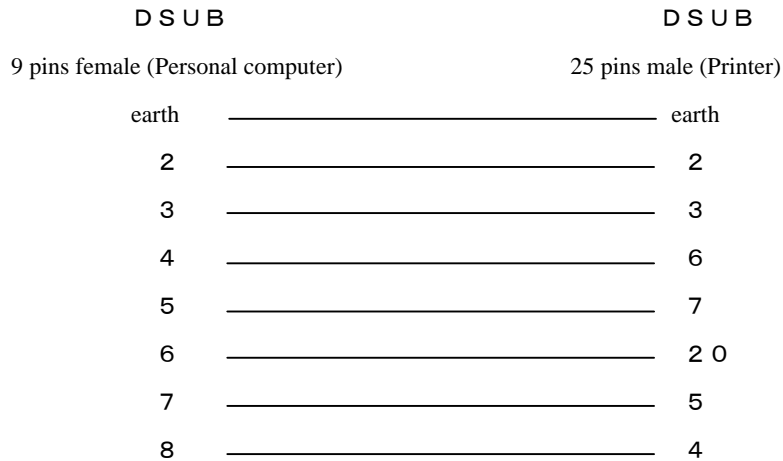

- A personal computer with 25-pin socket

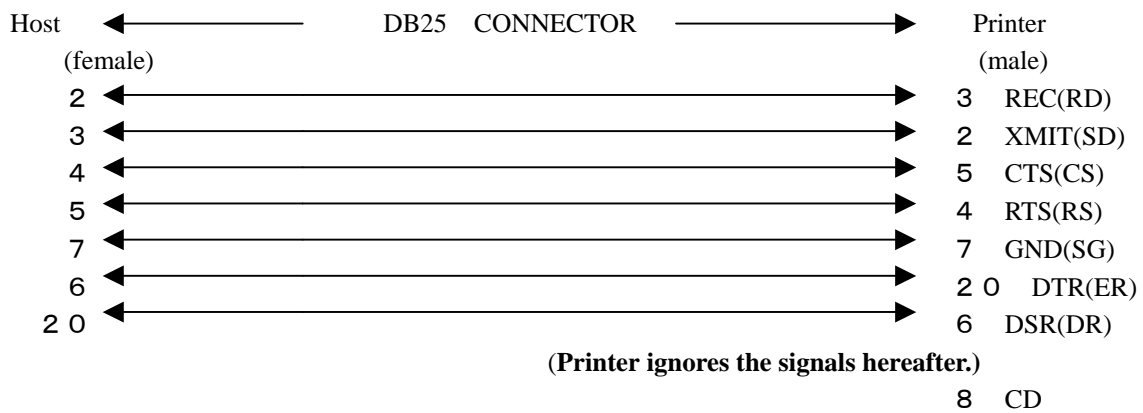

Also usable with parallel interface.

APPENDIX C Recommended Labels and Ribbons

RECOMMENDED LABELS AND RIBBONS

Use the specified labels and ribbons (ink ribbons) on this printer.

No.	Label	Ribbon
1	DURATAACK 10PN	DURAINK 10PN
2	DURATAACK PON	DURAINK 10PN
3	DURATAACK PT	DURAINK DLH
4	NP coated paper	DURAINK G
5	DURATAACK P	DURAINK DLH or H
6	DURATAACK S40H/C40H	DURAINK DWH
7	DURATAACK PF	DURAINK PF

Note:

Be sure to use the recommended labels and ribbons.

Using non-recommended labels or ribbons can result in problems such as poor print quality and damage to thermal head or other printer components.

Use non-recommended labels or ribbons on your own authority.

APPENDIX D Memory Card

Memory cards are used to store label format data. When using a memory card, you can print bar code labels simply by sending a format ID and the label data to the printer.

Memory cards are optional accessories.

Consult your dealer for details on how to write format information to memory cards.

Inserting the Memory Card

- ① Turn off the power to the printer.
- ② Insert a memory card into the slot, as illustrated below.
Make sure that the card is correctly oriented.

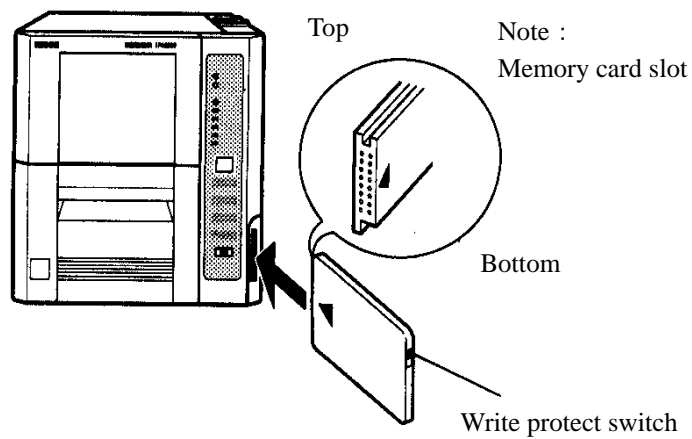

Note

The edge of the card will protrude slightly outward from the printer's side cover.

Before removing the memory card, be sure to turn off the power.

Loss of memory card data may result if the card is removed with the power turned on.

Memory Card Specifications

SRAM memory card

- JEIDA (Japan Electronics Industrial Development Association) IC memory card
- Guide Line Ver.4.1 (250 nsec access time)
- ML-64TB/ML-128TB/ML-256TB/ML-512TB/ML-1MTB/ML-1.5MTB/ML-2MTB
(Must be equipped with built-in backup battery: Hitachi Maxell Ltd.)

Note

- **Data in SRAM memory cards is backed up by a lithium battery. With the ML-64TB, backup battery life is about 5 years (at 20 °C).**
- **Replace the lithium battery with a new one before the old battery is completely exhausted. See the instructions provided with the memory card for the battery replacement procedure.**
- **Depending on usage conditions, the effective life of the backup battery may be reduced, resulting in possible data loss. Data can also be lost if correct procedures are not followed when replacing the lithium backup battery. Be sure to make backups of important data.**
- **If the printer's power is left on constantly, a printer error is displayed when the battery runs low. (This cannot be checked when the printer is turned off.)**

APPENDIX E Label Specifications

1. Layout of Page Detection Areas

(1) Backing paper (Interruptive-type center sensor)

There must be a backing paper position of 0.04”(2mm) to 0.20”(5mm) in direction of height. The width of the center part of the label must be 0.20”(5mm) or more.

The sensor output potential difference between label and backing paper must be 1V or more.

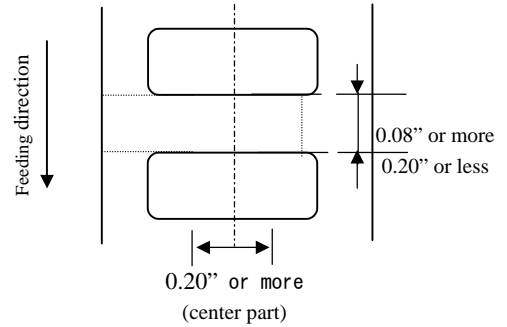

(2) Backing Paper (Interruptive-type form edge sensor)

The trimming in the left edge of the forms (looking from the front of the printer) must not be wider than 0.35”(9mm). The backing paper part between labels must be not less than 0.08”(2mm) and not more than 0.20”(5mm). The printing surface must be 0.24”(6mm) or wider.

The sensor output potential difference between label and backing paper must be 1V or more.

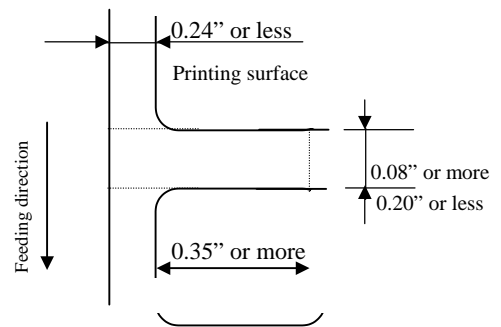

(3) Notches (interruptive-type form edge sensor)

In the left edge of the forms (looking from the front of the printer), there must be notches that satisfy the dimensions indicated below:

When page length is less than 2.75” (70mm):
0.35”(9mm)W or more × 0.08”(2mm)H to 0.16”(4mm)H

When page length is 2.75” (70mm) or more:
0.35”(9mm)W × 0.08”(2mm)H
to 0.47”(12mm)W × 0.20”(5mm)H

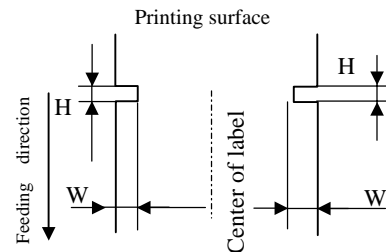

(4) Center hole (Interruptive-type center sensor)

Inner diameter: ϕ 0.12”(3mm) to 0.20”(5mm)

The center of the hole must be within 0.02” (0.5mm) of the center of the form width

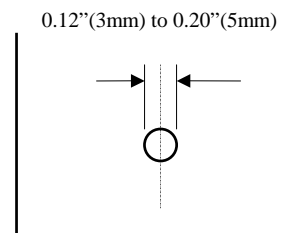

2. Miscellaneous (Printing Area)

The print position may vary slightly because of the error in manufacturing labels or the detection error by the sensor. Printing must occur within the shaded regions in the illustrations.

(1) Diecut forms

Page length up to 3.94"(100mm):

0.04"(1.0mm) or more (in direction of height)

Page length over 3.94"(100mm):

0.08"(2.0mm) or more (in direction of height)

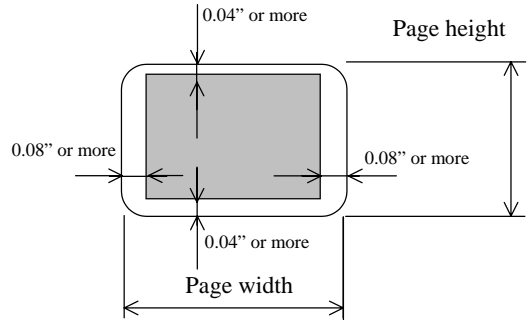

(2) Other than diecut forms

Page length up to 3.94"(100mm):

0.06"(1.5mm) or more (in direction of height)

Page length over 3.94"(100mm):

0.10"(2.5mm) or more (in direction of height)

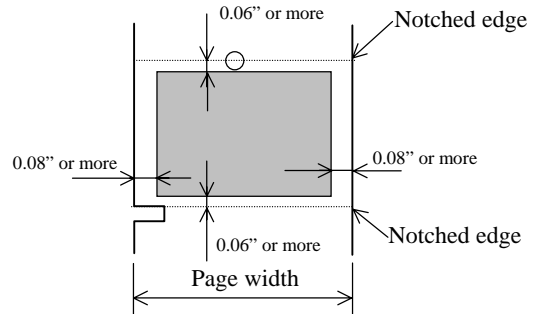

Note:

The dropped or blurred printing may occur outside the printing area.

Do not allow barcodes and characters to go over the edge of the label.

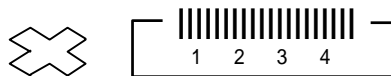

APPENDIX F The Position of the Thermal Head

- 1 . When the thermal head has been moved after replacing the ink ribbon or cleaning or replacing the thermal head, etc., make sure that the thermal head is returned to its correct position.
- 2 . See the illustration below. Move the thermal head forward, so that the positioning plates touch the screws. This is the correct position of the thermal head. The positioning plates and the screws are located on both sides of the thermal head. Make sure that the positioning plate on either side touches the screw.
- 3 . When the thermal head slips back, wrinkling of the ink ribbon or blurred printing may occur.

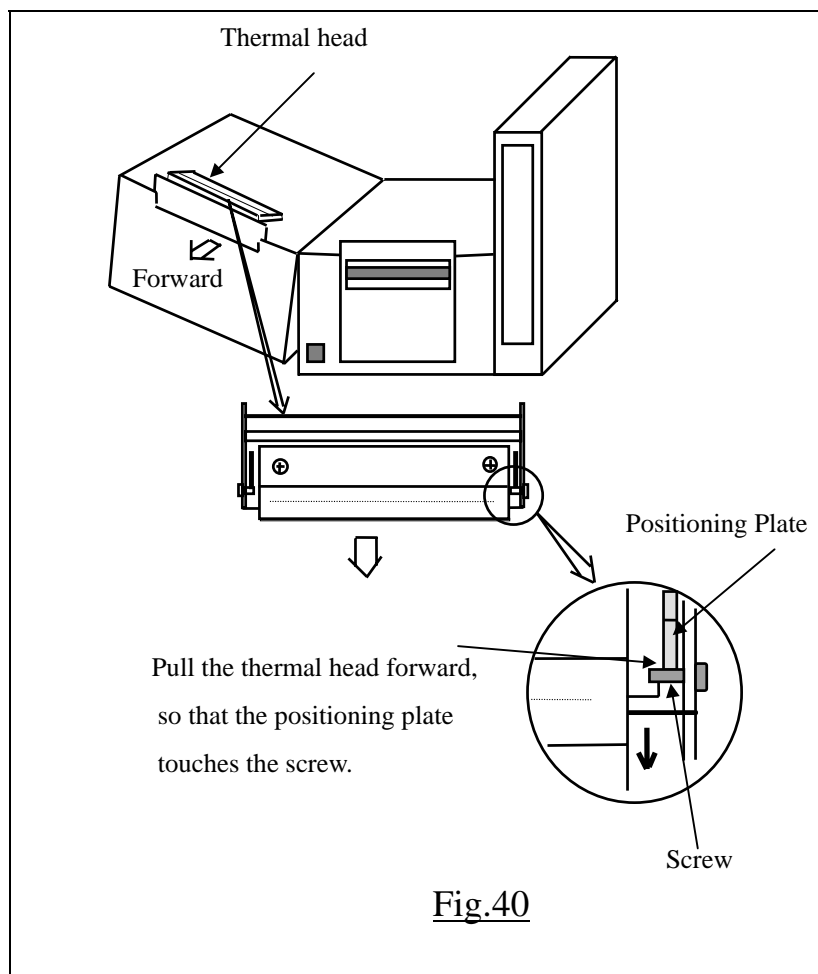

APPENDIX G Function Setting List

* The new setting becomes effective only after the power is turned on again.

(Note)The setting designated and sent from DURA RHYTHM is effective.

Function Number	Function	Setting Value	Setting	Setting History		
				Factory Setting	User setting	
0*	Length measurement method	1	Manual length measurement	1		
		2	Length measured automatically at power-on			
1*	Printer Configuration	1	Standard 1 (On-demand: long)	Printer only 1		
		5	Manual sticking mode			
		6	Mounter mode (automatic model)			
		7	Labeler mode (automatic model)			
		8	Standard 2 (On-demand: short)			
		9	Standard 3 (On-demand: half)			
2	Print starting position adjustment	1,9	0 0.005"(0.127mm) increments	1		
		2	+1			
		-				
		16	-7			
3	Verifier active	1	Verifier active, Verifier & APPC ON	1		
		2	Verifier active, Verifier & APPC OFF			
		3	Verifier active, Verifier OFF, APPC ON			
		4	Verifier inactive (Barcode not printed)			
4	Paper type	1	White labels (Center sensor)	1		
		2	Pre-printed labels (Center hole sensor)			
		3	Continuous forms (Center hole sensor)			
		4	White labels (Movable sensor)			
		5	Pre-printed labels (Movable sensor)			
5	On-demand quantity adjustment Paper feed length after printing	1,9	0	1		
		2	+1			
		-	- 0.025' (0.635mm) increments			
		16	-7			
6	Head check	1	Use when voids occur repeatedly (Normal)	1		
		2	Regular use			
7	Jam detection	1	More than 1.5 pages (Normal)	1		
		2	More than 3.5 pages			
8*	Form length setting mode	1	Set by measurement	2		
		2	Set by command (Normal)			
9*	Print method selection	1	Format printing (Label printing, Normal)	1		
		2	Text printing			
		3	Hex dump printing			
10	Supply Type	1	Supply 1 (PN label/paper label)	5		
		-				
		5	Supply 5 (PET label, PON label)			
		-				
		8	Supply 8 (S40H, C40H label, PON label)			
		9	Supply 9 (PET label, P label, PF label)			
11	Label transport speed	1	2.0 ips	1		
		2	1.75 ips			
		3	1.5 ips			
		4	1.0 ips			

DURAPRINTER SR

12	Returning from on-demand	1	Normal	1			
		2	Printer feeds backward one extra page before leading edge alignment.				
		3	Printer does leading edge alignment after returning from the on-demand position.				
13	Print speed	1	Maximum (Normal)	1			
		2	Minimum				
14	Engineering mode	-	Do not change the setting.	1			
15	Engineering mode	-	Do not change the setting.	1			

APPENDIX H The Front Label Positioning Method (Set TOF)

* It is for SR and SRs printer with the mode for peeler unit : Function No. 1 value is 5, 6 and 7.

We explain about the function of (Set TOF) button that uses it after loading labels, ink-Ribbon, & opening the cover by some reasons.

* On standard mode, it might be different 1st label position by label height and label pitch.

Be sure before operating the position of 1st label to user this function.

Procedure (Flow)

- (1) Open the printer cover, and set the label roll on the printer.
- (2) The label must be so that the front label is ahead of paper sensor.

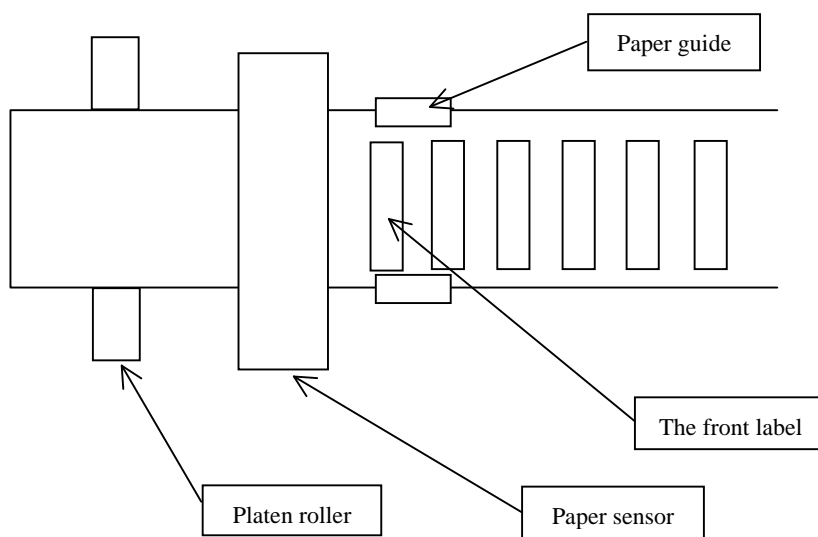

- (3) Hold the [Set TOF] button for several seconds.

Note: For the printer SRs hold the [ /Cut] button for several seconds.

The buzzer beeps.

- (4) Close the printer cover.

Several labels are fed.

Thus, the front label positioning has been completed.

- (5) Press the [Enter/Pause] button to set the ready state

(the green READY lamp lights).

If you use the peeler unit, please set as follow :

Be sure to open the peeler unit firstly, then set in accordance with the above method, and last, be sure to close the peeler unit with pull at the separator.

APPENDIX I Important Items of Daily Operation

1. Setting the Labels and Ink Ribbon

(1) Setting the labels

Set the labels straight without lateral deviation, using the edge of center fixing type sensor as a basis.

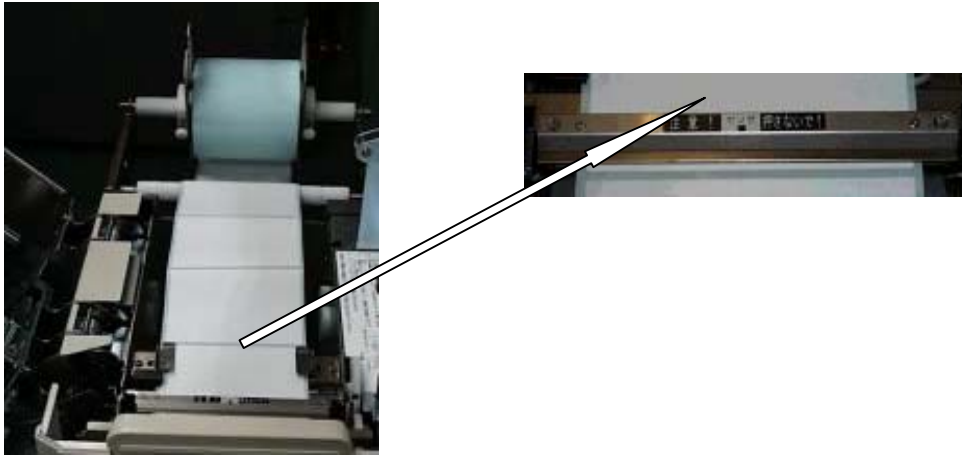

Pay attention to the paper feed pass when the external roll holder is used.

Label inside wind: From upper side (Label outside wind: From lower side)



(2) Setting the ink (ribbon)

Set the ink ribbon straight without lateral deviation (torsion) of ribbon being fed or taken up.

Good



Bad



2. Cares When Operating

(1) When supplies are replaced, the following requirements must be met.

[1] Do not turn off the power to the personal computer.

Otherwise the data sent from the personal computer are lost.

[2] When replacing supplies, do not wear metallic protruding articles, such as watch.

Otherwise the heating element of thermal head is damaged, resulting in wire breakage.

[3] Be sure to set the moving sensor (when it is used).

If the moving sensor was once shifted to a side for easier label setting, be sure to return it to its original position.

(2) Do not touch the following parts with bare hand.

[1] Label surface (print surface)

[2] Ink transferring surface

[3] Heating element of thermal head

(3) Do not press the center fixing type sensor with undue force.

* Label jam is caused.

* Do not remove the center fixing type sensor even when it is not used.

It serves to suppress label lift.

(4) During printing do not pull the label with undue force.

* Otherwise print deviation occurs.

(5) Do not tighten excessively the fixing screw for the backing of externally provided roll holder when the external roll holder is used.

* Otherwise normal rotation is disturbed.

3. Daily Check

The following daily check is required. After checking clean the machine as necessary according to the specified procedure.

(1) Checking before starting work at the beginning of week

[1] State of surface of thermal head: Flaw, sticking dust, extent of wear

[2] State of platen roller surface: Flaw, sticking dust

[3] Inside of printer: Existence/nonexistence of dust

[4] Externally provided holder: Sticking dust, checking of installation position

(2) Daily check

[1] Inside of printer: Existence/nonexistence of dust

[2] Thermal head: Existence/nonexistence of dust

3-1. Cleaning

This is important item in order to keep the printer in peak condition for a long time, be sure to perform the maintenance described below.

Clean the following parts according to the check cycle.

(1) Thermal head unit

- * Clean the parts in addition to the heating element.
- * Be sure to turn off the power before cleaning.
- * Cleaning should be performed before start of work.



Wipe the heat element component of the thermal head several times only in one direction



Put the winding ink ribbon on the V notch of Upper cover to see the thermal head surface correctly.

<Cleaning Cloth>

The cleaning cloth intended for the thermal head is packed with the printer or the thermal head at the time of purchase. The cleaning cloth is dampened with IPA and you can polish the thermal head most effectively with it.

Replace the thermal head if you cannot improve the print quality.

DURAPRINTER SR

(2) Platen roller unit

If contamination by paper dust is significant, take out the unit, and clean it.



Taking-out method: Releasing the left and right locks, remove upward.



Left lock



Right lock

(3) Paper sensor unit and Label output area

